



### Society ...

#### Four Guests Present at OEB Club Thursday

Four guests, Mrs. Henry Barjenbruch, Mrs. Ferris Warner, Mrs. Gus Hinrich and Mrs. Carl Johnson, were present at OEB Thursday. Prizes went to Mrs. Arnold Mau, Mrs. Robert Goodell and Mrs. Earl Larson. Mrs. Paul Bantmeyer was hostess.

#### Altona Aid Plans Family Night June 5

Attending the meeting of Altona Trinity Lutheran Ladies aid Thursday were 30 members and four guests. Rev. K. F. Wenzel read the scripture lesson and prayer. Topic for discussion was "Memo from Mon-

terey, Mexico." It was decided to have family night June 5. Mrs. Herbert Bergt gave a report on the Children's Home society auxiliary convention held last Tuesday at Madison. Mrs. Irvin Glimsmann and Mrs. Albert Greenwald served as hostesses.

#### Klick and Klatter Features "Tributes to Mother"

"Tributes to Mother" were given by 13 members of Klick and Klatter at Tuesday meeting. Mrs. Basil Osburn was hostess. Guests were Mrs. Don Johnson, Mrs. Julia Haas and Mrs. Dale Brugger. Mrs. Paul Stevers read an article on healthy children. Mrs. Rollie Longe read a poem. A report on the foreign aid program was made by Mrs. August Dorman.

Project for the afternoon was basket weaving. A special meeting will be held May 24 at the Rollie Longe home to continue the project. The next regular meeting will be a guest day tea at the Woman's club rooms June 14 at 2 p.m. Family picnic will be July 10 at Bressler park.

#### Twenty-five Attend OES Kensington Guest Meet

Fourteen members and 11 guests were present for OES Kensington guest day meeting Friday at the Masonic hall. Mrs. K. N. Parke was in charge of the program. Mrs. B. J. Brandstetter, Mrs. Ed Wolske and Mrs. Gus Hinrich sang "O Sunset Shore" accompanied by Barbara Wolske. Mrs. Orville Sherry reviewed parts of the book, "Mothers of America." Jim Hein played a coronet solo, accompanied by Phyllis Cook at the piano.

### Courthouse Roundup

#### Marriage Licenses

May 7: Donald R. Harmeier, Carroll, and Joyce E. Volwiler, Winside.

#### County Court, May 6

James L. Murphy, Walthill, fined \$25 and \$4 costs for possession of alcoholic liquor by minor; complaint signed by Clarence Mayhew. Franklyn E. Merchant, Spencer, Ia., fined \$25 and \$4 costs for possession of alcoholic liquor by minor; complaint signed by Clarence Mayhew.

Serving were Chairman Mrs. Tom Roberts, Mrs. Carl Lindvall, Mrs. Burrett Wright, Mrs. Walter Woods, Mrs. E. E. Fleetwood, Mrs. C. M. Craven and Mrs. Ismael Hughes.

#### Deaths Filed

May 2: Robert L. Wesely and wife to Herbert C. Mittelstaedt; lot 18, blk 7, Hoskins for \$1,700. May 4: Willie E. Miller to Ralph E. and Beatrice O. Prince; lot 4, Weible's 1st add, Winside for \$1,700. May 6: Herman W. Wacker and wife to Homer and Sylvia Sheppard; lots 13, 14 and 15, blk 27, College Hill add, Wayne for \$14,000. May 6: Eldon S. Fleming and wife to Jack L. Hurd; N 5 ft., lot 6, blk 9, College Hill add, Wayne for \$1.

#### Slates Tuesday Visit

Roman R. Hobza, field representative of the Omaha Social Security office will be at the Wayne courthouse at 1 p.m. Tuesday to assist retired individuals who wish to file claims for old-age insurance benefits. He will also aid those who wish to file for survivors insurance benefits.

#### 'I See by The Herald'

Mr. and Mrs. Jacob Schrock, Chenoa, Ill., visited at the Albert Bastian home from Monday to Wednesday. Rev. and Mrs. H. J. Diekhoff were Sunday afternoon callers at the home of Mr. and Mrs. H. W. Kugler. Diekhoffs and Kuglers attended the dedication of St. Paul's Lutheran church. Mrs. Mae Young spent the weekend with Will Neilsons, Columbus.

Mrs. Ray Perdue was a supper guest of Allan Perducs Sunday. Friday she called in the Lavern Kavanagh home, Carroll.

Mr. and Mrs. B. F. Strahan are moving from Cherokee, Ia. to Sidney where Mr. Strahan will enter the banking business with Leo V. Krieger. Mr. Krieger is husband of the former Betty Strahan.

Mr. and Mrs. Kermit Andrews, Gary and Larry, Fremont, Iowa Heikes, Omaha, Lyle Stern, Nalley, and Matty Beth Munsinger, Tabor, Ia., were Sunday evening dinner guests at the Charles Heikes home.

Mr. and Mrs. Lloyd Schindler and family, Hartington, visited Sunday at the Henry Weseloh home.

Mrs. Mary Schulte and Henry Schulte, Redwood, Calif., were dinner guests Sunday in the Victor Kriesche home. Mr. Schulte spent the past week here with his mother.

Mrs. Lillian Edwards, Cedar Bluffs, spent from Friday to Tuesday with friends and relatives here. She visited at the homes of Mrs. Marie Hansen, C. J. Perrin, Walter Miller, Otto Lutt and Ray Perdue.

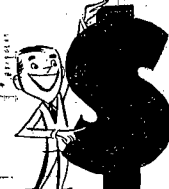

## TILLIES ... DOLLAR DAY VALUES

FRIDAY - SATURDAY  
MAY 13 - 14

Auto. Adding Machines, reg. 1.25 ..... 1.00  
Rose Beads, reg. 1.25 ..... 1.00

### Group of Planters

Reg. 1.25 — — 1.00

Salt and Peppers, reg. 1.25 ..... pr. 1.00  
Vases (Girl with Basket) reg. 1.25 ..... 1.00  
Rooster and Toothpick Centerpiece  
1.50 Value for 1.00  
Mary King French Milled  
Complexion Soap, reg. 1.25 ..... 1.00  
Face Powders and Cremes, reg. 1.25 ..... 1.00

## Tillie's Shoppe

319 Main Phone 307

# SAVE DURING OUR BIG MAY TIRE SALE

ANNOUNCING THE NEW

# Firestone Super Champion

Compare Its features WITH ANY 1<sup>ST</sup> QUALITY 1<sup>ST</sup> LINE TIRE

Now Firestone brings you a great new tire value at a sensational new low price. Through new production efficiencies, tremendous buying resources, use of rubber from our own plantations in Liberia and our own synthetic rubber plants and big economies in distribution and all other cost factors, you get this quality tire at a bargain price.

- LONG MILEAGE**  
New, tough, abrasion-resistant tread compound assures you of many thousands of miles of safe, dependable tire performance. You get most miles per dollar with a Firestone!
- BLOWOUT SAFETY**  
Firestone's new Safety-Tensioned Gum-Dipping Process gives you the strongest, safest body ever built into a tire. This means greater blowout protection and longer tire life.
- LIFETIME GUARANTEE**  
No limit as to time or mileage. Firestone Dealers and Stores have pledged to give you prompt, courteous and satisfactory service whenever you need it, wherever you are!
- NON-SKID PROTECTION**  
The famous tread design is road proved ... with millions and millions of miles as original equipment on the finest cars.

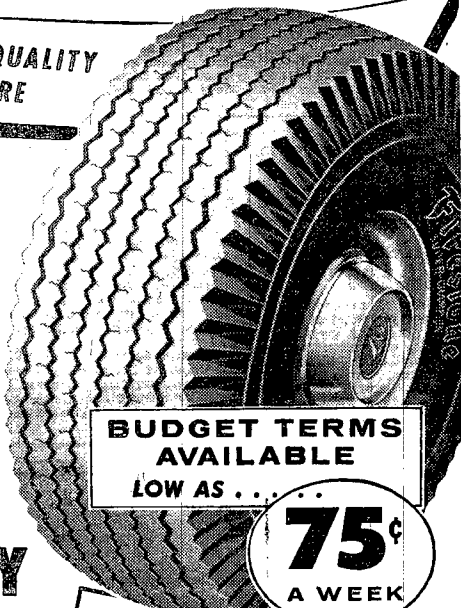

**BUDGET TERMS AVAILABLE**  
LOW AS ... **75¢** A WEEK

## SPECIAL INTRODUCTORY SALE PRICES

DON'T MISS THIS LOW, LOW SALE PRICE

# 14.25

SIZE 6.00-16 Plus Tax Exchange If Your Old Tire Is Recappable

**OTHER SIZES SALE PRICED TOO! BOTH BLACK and WHITE SIDEWALL**

SIZE	BLACK Special Trade-In Price	WHITE BLACK Special Trade-In Price
6.40-15	15.15	
6.70-15	15.95	
7.10-15	17.60	19.45
7.60-15	19.25	21.55
6.00-16	14.25	17.45
6.50-16	18.90	23.15

\*Plus Tax and your old recappable tire

**AMAZING OFFER** Bring Your Present Car Up-To-Date Regardless of Year or Make With FIRESTONE DELUXE CHAMPION TUBELESS TIRES Without Changing Your Present Wheels or Rims. Come In . . . We'll Buy all the Unused Mileage in Your Present Tires When You Trade for New Ones.

**SPECIAL SALE PRICES ON ALL TIRES ... ALL SIZES**

**BIG SAVINGS**

**Firestone CHAMPION**

- NON-SKID SAFETY
- LONG MILEAGE
- FULL VALUE

SIZE 6.00-16 **11.95** PLUS TAX EXCHANGE IF YOUR OLD TIRE IS RECAPABLE

SIZE 6.70-15 **13.45** PLUS TAX EXCHANGE IF YOUR OLD TIRE IS RECAPABLE

OTHER SIZES ALSO REDUCED

**TRUCK OWNERS Save Money Too!**

**Famous Firestone TRANSPORT B-112 HEAVY DUTY**

**Only \$19.95** PLUS TAX EXCHANGE IF YOUR OLD TIRE IS RECAPABLE

Other Sizes at Big Savings

**TOP QUALITY**

**Firestone DELUXE CHAMPION**

- Blowout and Puncture Protection
- New Silent-Ride Safety-Grip Tread
- Greater Riding Comfort

SIZE 6.70-15 **21.20** PLUS TAX EXCHANGE IF YOUR OLD TIRE IS RECAPABLE

OTHER SIZES ALSO REDUCED

# MERCHANT OIL CO.

121 WEST FIRST WAYNE PHONE 99



## Swans' Clothing Has Dollar Day Values

### SHOE CLEARANCE

Special Selection of Close-Out Styles  
Not All Sizes — Values to 12.95

# 5.88

**Sport Shirts**  
Long and Short Sleeve in Fancy Novelties and Plainer Tones  
VALUES TO 4.95 **1.00**

**Trousers**  
One Group with Savings Up to **1/2**

**Extra Special**  
7 PAIRS OF 10' **Engineer Boots**  
REG. 12.95 **7.88**  
SIZES 7 1/2 TO 10

**T-Shirts**  
Reg. 79¢ Campus Brand **2 for 1.00**

**Utility Sox**  
Gray or White Fine Mercerized Cotton by a Brand Name. First Quality.  
**6 pairs 2.00**

**Handkerchiefs**  
White, Large Size Hemstitched **12 for 1.00**

**BOYS' Spring Jackets**  
From Our Regular Stack of Reversibles, Washables and Dress Types. A Big Saving at **3.99**

**BOYS' Sport Coats**  
Tailored by Tom Sawyer with Suit Coat Tailoring — One Group to Go at **1/2 price**

**Boy's Gabardine Trousers 1.99**  
Tom Sawyer Construction in Blues, Greys, Tans — Sizes 6-12

For Men Who Want the Best

## OSHKOSH B'GOSH

We carry a complete stock of this famous make WORK CLOTHING

Overalls, Jackets, Coveralls, regulars, longs or shorts.  
Chambray Work Shirts, regular, long or short sleeves.  
Men's and Boys' Jeans. Matched Pants and Shirts.



# SWANS' CLOTHING

FOR MEN AND BOYS



# Four NCC Champions Vie in College Invitational Today

## Four Schools Entered in Night Meet

Four NCC track champions will compete in the annual Wayne State invitational track meet at the college stadium tonight. Athletic Director Chuck Obye announced this week.

Four teams will compete for the meet title. Chadron, Nebraska Wesleyan, Midland and Wayne. The meet will start at 6 p. m.

Chadron boasts two of the

# Sports News

champions in Bill Murphy, 880 title holder, and Larry Turner, javelin champion. Wayne has the low hurdle leader in Captain Glen Gotschall and the top mile relay team composed of Don Flynn, Ken Frazier, Gery Eaves and Ken Rapp.

Several other events will feature keen competition. Wayne's Captain Ken Rapp faces Wesleyan's Loren Eigenberg in the 440.

Eigenberg was runner-up in the conference meet.

Eaves will battle Murphy for the 880 title. The Wayne half-mile posted a 2:00.7 repetition. Turner will get stiff competition in the javelin, from Wayne's Bob Ohlund and Fran Harnis. Hot battles are also expected in the high jump and 220.

The time schedule and meet records: 6 p. m. shot put (43-11 1/2) and high jump (6-11); 6:30, discus (137-6 1/2) and broad jump (21-10); 7: javelin (182-6) and pole vault (12-6 1/2); 7:15, 880 relay (1:31.2); 7:25, mile run (4:25.5); 7:35, 440 dash (1:51.8); 7:45, 100 (1:01.0); 7:55, high hurdles (15.6); 8:05, 880 (2:01.9); 8:15, 220 (22.4); 8:25, two mile (9:57.6); 8:40, low hurdles (25.2); and 8:55, mile relay (3:30.4).

# News of Wayne Churches

**Grace Lutheran Church**  
Missouri Synod  
(E. J. Bernthal, pastor)  
Thursday, May 12: No junior choir. Senior choir, 8 p. m.  
Friday, May 13: Confirmation class, 7 p. m.; adult membership group, 8 p. m.  
Saturday, May 14: Confirmation class, 1:30 p. m.  
Sunday, May 15: Sunday school and high school youth Bible class, 9:30 a. m.; adult Bible study, 9:10; worship service, 10:30. Examination of catechisms.

**First Presbyterian Church**  
(Oliver B. Proett, pastor)  
Sunday, May 15: Church school, 9:45 a. m.; nursery and pre-school, 11; worship, "God's Earth," and special music, 11.  
Tuesday, May 17: Men's council ladies' night.  
Wednesday, May 18: Women's association, 2:30 p. m.; Westminster-Pilgrim fellowship, 6; Westminster fellowship (high school), 7:15.

"Captives of Ignorance," 10:55 (4-H members will be guests of honor and participate in the service.)  
Wednesday, May 18: Youth choir, 6:30 p. m.; Chancel choir, intermediate fellowship, 7.

**Redeemer Lutheran Church**  
(S. K. deFreese, pastor)  
Thursday, May 12: Missions for members meet at 1:30 p. m. for transportation to Concord.  
Sunday, May 15: Early service, "Life Defined," 9 a. m.; Sunday school, 10; late service, 11.  
Tuesday, May 17: Brotherhood, 8 p. m.

## SOUTHEAST Wayne

By Staff Correspondent

**Immanuel Lutheran Church**  
Missouri Synod  
(T. H. Buchner, pastor)  
Saturday, May 14: Saturday school, 9 a. m.  
Sunday, May 15: Worship service 10 a. m.; Sunday school, 11:15 p. m.; May 17: Adult instruction class, 7 p. m.  
Wednesday, May 18: Bible study group meeting, 8 p. m.  
Thursday, May 19: Ladies aid, 2 p. m.; Ascension day service, 8 p. m.

**Westleyan Methodist Church**  
(M. H. Buchsiek, pastor)  
Thursday, May 12: Women's Missionary society meeting, 2:30 p. m.; Bible study and prayer meeting, 8 p. m.  
Friday, May 13: Sunday school for all ages, 10 a. m.; morning worship, 11; No youth service or evening gospel hour because of high school baccalaureate.

**Church of Christ**  
(A. Paul Cook, pastor)  
Friday, May 13: Mother-daughter banquet, 6:30 p. m.  
Sunday, May 15: "The Living Word," 8 a. m.; Bible school, 10; morning worship, "God Hears from Heaven" following the Lord's Supper and special music, 10:35; Christian Young Peoples' meetings, 7 p. m.  
Wednesday, May 18: Booster club and prayer meeting, 8 p. m.; Growing in Grace study, 8:10.

**Altona Trinity Lutheran Church**  
(K. F. Wenzel, pastor)  
Sunday, May 15: Divine service, 10 a. m.  
Monday, May 16: Walther League, 8 p. m.

140 and placed third as Tekamah's Bruce Skinner set a new mark of 52.4.  
Wayne's mile relay team finished second behind Blair to earn a state berth. Hofeldt tied for third in the high jump and thus qualifies for the Lincoln meet in that event.  
Winside also had two qualifiers in Class C competition. Dean Janke capped the high hurdles in 16.1 and LeRoy Henot tied for first in the high jump at 5-5.

## Nearly 200 at Athletic Fete Monday Night

Nearly 200 athletes, coaches, faculty members and businessmen attended the annual WSTC spring athletic banquet Monday night at the student union dining room.

Guest speaker was Warren Gaer, Drake university football coach. Recognition of athletes was also made by Athletic Director Chuck Obye.

He presented most valuable player trophies to Don Keltog, football, and Wayne Samuelson, basketball.

Announcement of the outstanding freshman athlete award and track's most valuable player will be announced upon completion of the season, Obye said.

Presentation of basketball letter certificates was also handled by Obye. Dr. J. R. Johnson was toastmaster. President John Rice gave the welcome and Milton Hassel led the invocation.

## Wayne Qualifies Six in State Cinder Steer

Paced by Larry Hofeldt's record shotput toss, Wayne High qualified six men for the state track meet in district competition Friday at Norfolk.

Hofeldt, the husky junior, posted his best toss of the season with a 50-1/2 toss Friday morning. That was 3 feet, 5 1/2 inches better than the record set by Tekamah's Don Thomas in 1951. It ranks as the top toss in Class B throughout the state.

Bill Kern qualified in the sprints by taking third in both the 140 and 220. Jerry Hennelsson continued to show improvement in the

# 'I See by The Herald'

Mr. and Mrs. Paul Schroeder, Oakland, spent Saturday and Sunday with their parents, Mr. and Mrs. Paul Schroeder, sr. and Mr. and Mrs. Glenn Houshelt.

Mr. and Mrs. Arlen Fitch and family went to Plainview Sunday and visited in the Clyde Fitch home.

Mr. and Mrs. Otto Gerleman and Mr. and Mrs. Herbert Gerleman and Joanne went to Omaha and were guests of Marvin Gellers Sunday.

Dinner guests in the Earl Merchant home Sunday were Mr. and Mrs. Robert Merchant and family.

Mr. and Mrs. Henry Arp and Mr. and Mrs. Emfrid Allvin were dinner guests in the home of their son and daughter, Mr. and Mrs. Henry A. Arp, Carroll.

Mrs. Mae Young was in Columbus Sunday as a guest in the William Nelson home. Mrs. Nelson is Mrs. Young's daughter.

Mr. and Mrs. Harvey Kammann and son, Holdrege, came Saturday to spend the weekend with her parents, John Dunklau. Saturday evening guests in the Dunklau home were Mr. and Mrs. Lloyd Dunklau and family, Mr. and Mrs. Eldin Roberts and family, Mr. and Mrs. Alden Dunklau and family, and Mr. and Mrs. Marvin Dunklau and family. Sunday for dinner Mr. and Mrs. Kenneth Dunklau and family were the guests and later that afternoon Marvin Dunklau were callers.

Oscar Liedtke spent Saturday and Sunday in Ida Grove, Ia., visiting her aunt, Mrs. Fred Hansen.

# BASEBALL TONIGHT

8:15 p.m. Wayne Ball Park

# WAYNE vs. WSTC

Admission: 25c

# Don't Miss The Big BASEBALL BENEFIT DANCE

Wayne City Auditorium

# FRIDAY, MAY 13

## Top Honor Gifts for Graduates!

From WAYNE BOOK STORE



Stop in Today!  
**FOUNTAIN PENS**  
• Sheaffer • Parker • Eversharp  
NAME FREE ON ANY PEN

**TYPEWRITERS**  
• Royal  
• Smith-Corona  
• Underwood  
• Remington

Only \$1.00 Per Week  
After a Small Down Payment

• STATIONERY • PHONOGRAPHS  
• GREETING CARDS • Thank You NOTES

Wayne Book Store  
"We Sell Almost Everything"

219 Main Phone 110

FRIDAY - SATURDAY MAY 13-14 IN WAYNE

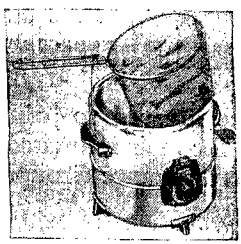

Nationally Advertised  
**Deep Fat Fryers**  
Regularly 39.95 - Limited Supply  
Guaranteed by Good Housekeeping  
**14.95**  
DOLLAR DAYS ONLY

50-Foot Plastic  
**Garden Hose 1.99**  
Regular 3.95

**TIEDTKE**  
PLUMBING, HEATING & APPLIANCES

108 Main Phone 268

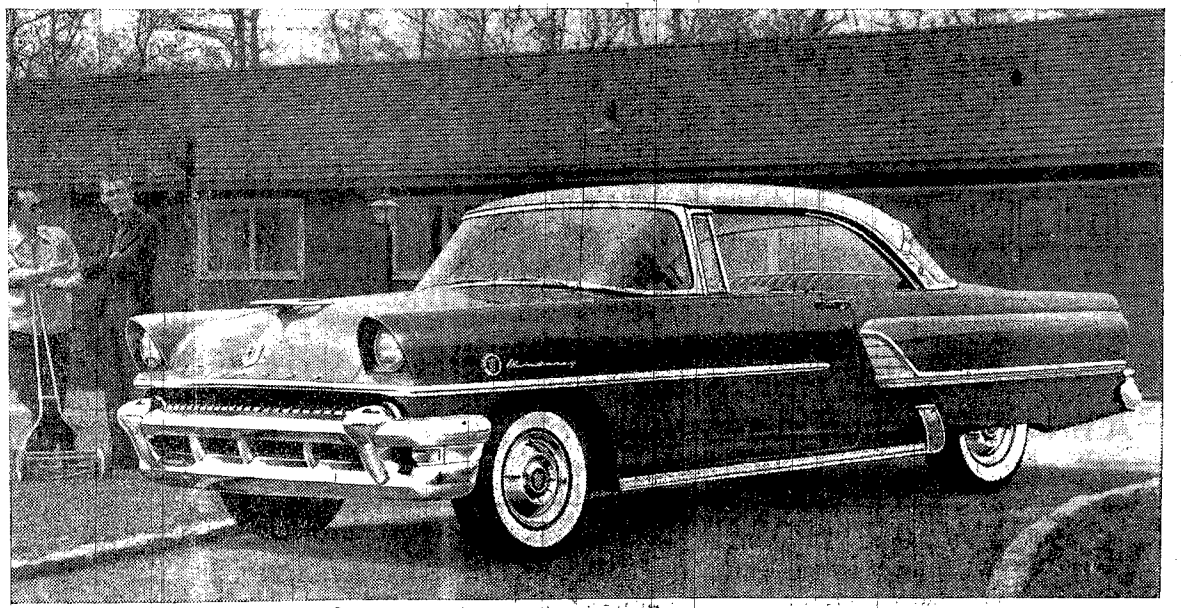

ONE LOOK and you know it's a Mercury. Exclusive Mercury styling is shared by no other car. The smart Monterey Coupe shown above is one of 11 Mercury models in 3 series.

# Let us show you 5 ways you'll save with Mercury's Easy-Ownership plan

Come in today. Let us show you how we—and Mercury—can cut your costs at every stage of car ownership

- You can get more for your present car.** Let us show you how Mercury's record-breaking sales put money in your pocket. High volume lets us give a generous offer.
- You save on first cost.** Mercury prices start below 13 models in the low-price field.\*
- We arrange the easiest of terms.** They are tailored to fit you personally.
- You save on operating costs.** Mercury's traditionally famous economy, low upkeep will save you money every mile you drive.
- You save on future trade-in.** Mercury consistently leads its class for resale value. You can get a higher allowance for your Mercury at trade-in time.

\*Based on a comparison of manufacturers' suggested retail prices.

- NO OTHER CAR OFFERS YOU BIGGER REASONS FOR BUYING IT
- Exclusive styling shared by no other car
  - New SUPER-TORQUE V-8 engines on every model (188 and 198 horsepower)—Lacked by Mercury's record of producing V-8 engines exclusively
  - 4-barrel vacuum carburetor on every model at no extra cost
  - Dual exhausts at no extra cost on all Montclairs and Montereys
  - Ball-joint front-wheel suspension
  - Anti-fouling high-compression spark plugs
  - Consistently highest resale value in its field, according to authoritative reports

IT PAYS TO OWN A **MERCURY** FOR FUTURE STYLING, SUPER POWER

Don't miss the Jay television hit, Ed Sullivan's "TOAST OF THE TOWN," Sunday evening, 6:00 to 7:00, Station KFTV, Channel 9.

**SEYLER MOTORS**

119 East Third Dayne, Nebraska Telephone 303



# Weddings

**Betty R. Brock Weds Charles Soderberg At Salem Sunday**

Wakefield — Betty Rosemary Brock became the bride of Charles Paul Soderberg Sunday in the Salem Lutheran church. Parents of the couple are Mr. and Mrs. Lawrence Brock and Mr. and Mrs. Paul A. Soderberg.

Rev. C. Willard Carlson performed the double ring ceremony. The altar was banked with palms and baskets of white calla lilies. Larry Ring sang "Through the Years." Sharon Henningsen sang "With This Ring I Thee Wed." Mrs. Carlson accompanied at the organ.

The bride wore a gown of white chantilly lace and nylon tulle. A portrait bodice and skirt panelled of lace was enhanced by applique scattered with iridescent sequins at the throat and outlining a scoop shoulder line. Her full train was of lace and tulle. She wore a Juliet cap of lace and seed pearls which held a full length veil of chantilly lace mandala, an heirloom worn by her mother. She carried an orchid and white Bible.

Mrs. Harold O. Tell, Camanche, Ia., was matron of honor for her sister, Jacqueline and Judith Brock, twin sisters of the bride, were junior bridesmaids. Mrs. Conrad Laursen, Paulina, Ia., and Jacqueline Soderberg, Omaha,

# Winner Gets Sewing Machine



Mrs. George Mesch, Stanton, is shown at right above accepting congratulations from Mrs. P. A. Pawelski as winner of Larson's annual sewing contest.

Second and third prize winners were Blanche Collins and Mrs. Roy Coryell, Wayne. Teen-age prize winners were Margaret Christensen, Laurel, first, and

Phyllis Cook, Wayne, second. Honorable mention winners in both divisions were: Mrs. Edwin Lentz, Wakefield; Mrs. Coryell; Mrs. Clarence Granquist, Wayne; Mrs. Fred Ruser, Wayne; Mrs. Mesch; Marilyn J. Richter, Wayne; Lois Tischer, Wayne, and Joyce Cook, Wayne.

The bride chose a two-piece navy blue dress with white accessories for her going-away ensemble. After a trip to Colorado the couple will make their home in Wakefield.

**THIS COUPON \$1 GOOD FOR**

ON THE PURCHASE OF 1/2 TON OF ANY OF OUR FEEDS DURING

**Dollar Days, May 13-14**

BRING COUPON IN WITH YOU TO

**Sherry Bros. Produce**

CONCORD WAYNE CARROLL

**Volwiler - Harmeier Rites Held Sunday In Carroll Church**

Carroll — Joyce Elaine Volwiler, daughter of Mr. and Mrs. Clarence Volwiler and Cpl. Donald R. Harmeier, son of Mr. and Mrs. Ray Harmeier, were married Sunday in the Methodist church with Rev. C. L. VanMetre officiating.

Nuptial music was furnished by Mrs. Roscoe Jones, Wayne. Soloist was Albert Ermeis, Bloomfield, who sang "Because" and "The Lord's Prayer." He was accompanied by Mrs. Jones.

Bridal wreath, white lilies, chabudis, snowballs and candleabra formed a background for the ceremony.

The bride, given in marriage by her father, wore a ballerina length gown of nylon embroidered net with strapless basque bodice and embroidered net jacket. Her veil of lace trimmed nylon net fell from a crown of seed pearls and rhinestones. She carried a cascade arrangement of red roses.

Mrs. Loren Stoltenberg was matron of honor and Mrs. Dale Stoltenberg bridesmaid. Both wore white ballerina length gowns of nylon net over taffeta. They wore braided coronets of rhinestones and net and carried colonial bouquets. They are sisters of the bride.

Donald Horn, Omaha, was best man. Tom Lindsay, Wayne, was groomsmen. Gordon Davis and Bill Kenny were ushers. All wore dress suits with white jackets and dark trousers.

Candlelighters were Mrs. Charles Whitney and Jany Hal- leen. Both wore white ballerina length formals. Nancy Jo Miller was flower girl and wore a white nylon dress. Duane Miller was ring bearer and wore a white jacket and dark trousers.

The bride's mother wore a navy blue dress with white accessories. The bridegroom's mother also wore a navy dress with pink corsages. Both wore corsages of pink carnations.

A reception was held in the church parlors. Janice Shieffer, Crofton, had charge of the guest book and Mrs. Vermond Nelson and Mrs. Burton Shelberg, Wausa, the gifts. Mrs. Henry Ketsel- son, Plainview, poured. Mrs. Charles Hoffmeister, Champion, cut and served the four-tier cake, baked and decorated by mothers of the couple. Waitresses were Mrs. Gordon Davis and Maryann Claus, Wayne.

Assisting in the kitchen were Mrs. Erwin Vahlkamp, Mrs. Keith Reed, Mrs. Harry Miller, Mrs. Henry Worrelman, Mrs. Glen Gathie and Mrs. Raymond Hansen. Mrs. Worley Benschoff was toastess.

The bride graduated from Carroll high school, attended WSTC and taught the past two years in District 48. The bridegroom attended Wayne High and is serving in the Army at Ft. Devens, Mass.

For her going-away ensemble the bride chose a grey suit with accessories. After a short trip the couple will return to spend a few days with relatives. She will then accompany her husband to Massachusetts. After he receives his discharge in the fall they will make their home in Carroll.

Out-of-town guests came from Omaha, Grand Island, Champion, Jenango, Belden, Wausa, Bloomfield, Plainview, Norfolk and Crofton.

Mr. and Mrs. Ernest Echtenkamp spent Thursday evening at Don Kochs, Laurel, Sunday they were among guests for dinner in the Jack Erwin home, Concord.

Mr. and Mrs. Herman Echtenkamp went to Wakefield last Sunday evening to visit in the Fred Lehman home.

Mr. and Mrs. LeRoy Eliason and family, Wahoo, were dinner guests Sunday in the Laurence Ruwe home. Mrs. Eliason is a daughter of the Ruwes.

Mr. and Mrs. Herman Geewe and Verna Mae spent Thursday evening at Willard Hammers, holding them celebrate their fifteenth wedding anniversary and also Mr. Hammer's birthday.

Last Monday evening Mr. and Mrs. Herman Geewe and Verna Mae were guests of Mrs. Esther Fuoss for her birthday.

Mr. and Mrs. Anton Granquist were dinner and luncheon guests last Sunday in the Glenn Granquist home.

Glenn Granquist spent Sunday evening with T. H. Hughes.

Buy a 3-year WAYNE HERALD Subscription

Here are **Gifts** to make grads Glad!

**AT DOLLAR DAY PRICES**

**PARKER Pen and Pencil Sets**

**PARKER "21" SET** 625  
Reg. 8.75

**PARKER "51" SET** 1425  
STANDARD — Reg. 18.25

**PARKER "51" SET DELUXE**  
A \$22.50 Value For 1750

**FELBER PHARMACY**  
OVER 48 YEARS OF RELIABLE PRESCRIPTION SERVICE  
2 REGISTERED PHARMACISTS TO SERVE YOU

# More Fine-Car Features than any other car priced so low!

**POWER**—Pontiac's husky 200-horsepower Strato-Streak V-8 with four-barrel carburetor, optional at low extra cost, delivers more power than any car within hundreds of dollars of its price. And road records show this power is teamed with the greatest economy in Pontiac history.

**STYLE**—No car at any price is so beautifully distinctive. Pontiac's future-fashioned Twin-Streak styling and Vogue Two-Toning set it apart from all other cars—point the way to tomorrow.

**SIZE**—Pontiac is a big car where it counts— with a long, road-hugging 122" or 124" wheelbase. On any road, at any speed, you enjoy the feeling of genuine fine-car size.

**COMFORT**—Pontiac's extra size means big-car comfort—room to stretch out and relax. Wide-stance rear springs and Shock-Proof chassis float you along in luxury style.

IF you were to guess Pontiac's price on the basis of its style, performance and size, you'd surely guess hundreds of dollars higher than its actual cost. Pontiac measures up with the finest on any point of comparison—except price.

It's a simple matter of fact that you can buy a big, powerful Pontiac for less than many models of the lowest-priced cars and much less than stripped economy models of higher-priced makes!

After a close inspection of Pontiac's luxury and quality and a few miles commanding its mighty 200-horsepower Strato-Streak V-8, buyers from both ends of the price scale are switching to Pontiac in record-breaking numbers. Come in soon for the clinching facts and figures. You'll make the very pleasant discovery that if you can afford any new car, you can afford a big, powerful Pontiac—and step directly into the fine-car class!

**SEE AND DRIVE HISTORY'S FASTEST-SELLING Pontiac**

**Ed Wolske Auto Service**

216 West First Wayne, Nebraska Telephone 95

**DOLLAR DAYS SPECIALS at Gambles**

Reg. 1.29 4-Sewed Household Brooms \$1

10-inch PIPE WRENCH \$1 Reg. 1.79

50-yard Spool — 20-lb. Test CASTING LINE \$1 Reg. 1.35

2-pc. Wool Frieze LIVING ROOM SUITE One Only — Reg. 149.95 \$100

16-oz. CLAW HAMMER \$1 Reg. 1.45 Defiance by Stanley

Folding Hardwood and Canvas CAMP STOOLS \$1

2-PC. SECTIONAL New Modern Fabrics \$100

**1955 Coronado Automatic Washer** Reg. 209 \$165

**Gambles** The Friendly Store

# City Wide

## Boys' Denim Jeans

Sizes 2 to 12

You will find the big Dollar Day bargains at Larson's this weekend. See these sturdy sanforized blue denim jeans for boys in sizes 2 to 12.

**\$1**

## Men's White T-Shirts

Nylon Neck

Here is the buy of the year. Men's white T-shirts with the miracle nylon neck. Will wash many, many times and hold its original shape. Sizes small, medium, and large.

**2 for \$1**

## Flour Sacks

100-lb. Size

These are full 100-lb. size flour sacks, washed and mangled, ready for use. They are unopened. Every one guaranteed first quality, free from any printing or holes.

**4 for \$1**

## Bath Towels

Cannon

Regular \$1.49 Value

Here is the biggest bath towel that you have ever seen for only a dollar. Extra heavy, extra large and extra absorbent. Be sure to see this bargain.

**\$1**

Guest—2 for \$1

Wash Cloths—4 for \$1

## Men's Leather Gloves

Horsehide — Deerskin

Take a look at this assortment of quality work gloves. Included are genuine horsehides and deerskins. All first quality.

**\$1 pr.**

## Men's Work Shirts

Sanforized

This big roomy sanforized Pepperel chambray shirt going this weekend for only \$1 each. All sizes from 15 to 17. Hurry down for this bargain.

**\$1**

## 36 in. Bleached Muslin

A Real Buy!

Take a look at this outstanding value for Dollar Days. First quality, pure white sheeting. Full 36 inches wide. Buy your supply now and save.

**6 yds. \$1**

## Rag Rugs

24 x 48

Be sure to see this beautiful and practical rag rug. Not the ordinary type of rug that you see at this price. It is colorful, extra heavy weight and big in size. All guaranteed washable.

**\$1**

## Printed Pillow Cases

Here are those popular printed pillow cases. A wide variety of patterns to choose from. Buy them Friday and Saturday and save.

**\$1 pr.**

## Stamped Pillow Cases

First quality, type 128 stamped pillow cases. Hemstitched. See this bargain in our budget basement.

**\$1 pr.**

# Dollar Days

## Over 1000 Yards COTTONS

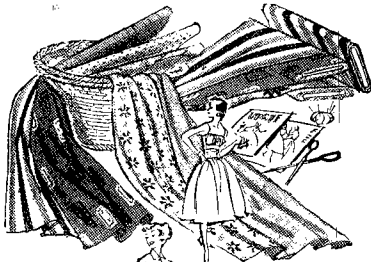

All off the Bolt

Worth up to 98c yard

Here is a big assortment of beautiful and attractive cottons, including such famous fabrics as sport denim, chambray, gingham, broadcloths, sheer goods and even printed and plain sheer nylon. Be sure to shop for this big bargain early Friday morning.

**2 yds. \$1**

## Sheer NYLONS

60 Gauge  
Fancy Heels  
Dark Seams

• Phoenix  
• Tru-Tone

**\$1.00 pr.**

Here is an offering of beautiful first quality sheer nylon. Every pair worth much more, such famous brands as Phoenix and Tru-Tone.

Main Floor



## Friday & Saturday

May 13 and 14

## Cotton Blouses

Sanforized

See this showing of cotton blouses in our ready-to-wear section. All sanforized shrunk. Many sleeveless styles in printed or plain colors. A lot of whites to choose from, too.

**\$1**

## Ladies' Rayon Gowns

Philmaid Irregulars

Here is a bargain that will go fast. We have a limited quantity to offer, so we urge you to be here early Friday morning. These are slight irregulars of famous Phil Maid gowns that sell regularly for \$1.98 and more. All sizes.

**\$1**

## Ladies' Rayon Pants

Irregulars of 59c and 79c Values

Another bargain that won't last long. Only 300 pair of these fine quality rayon pants, termed as irregulars, which would sell in first quality at 59c and 79c a pair.

**3 pr. \$1**

## Children's Play Wear

Big Assortment

Just in time for summer and vacation wear. All kinds of play clothes for little boys and little girls. Shorts, sun suits, rumba suits, fancy pants, sport shirts, etc.

**\$1**

## Costume Flowers

Regular 69c

Just received a new shipment of beautiful costume flowers, featuring a large selection of whites. See them. Friday and Saturday and save. Yes, they are going at

**2 for \$1**

## Silk Neck Squares

Regular 49c

Here is another big buy made special for Dollar Days. These beautiful pure silk neck squares that sell regularly for 49c. Shop Friday and Saturday for bargains.

**3 for \$1**

## Jewel Boxes

Just 60 to Go

You will be pleased with this beautiful jewel box going for only a dollar. A nice convenient size with lid, lock and key. Assorted colors.

**\$1**

## Baby Doll Pajamas

Sizes 2 to 8

Here are the popular 2-piece baby doll pajamas for little girls, sizes 2 to 8. Made of non-iron plisse crepe. A nice rose bud pattern. Hurry for this bargain.

**\$1**

## Children's Anklets

Sizes 4 1/2 to 8

Children's anklets made by Gordon. All regular 39c or 49c values. Assorted colors of blue, green, yellow, maize, red and lilac.

**4 pr. \$1**

## Skirt Totes

Here is the skirt tote that you can use in storing your can-can petticoat. Regular \$1.98 value. Friday and Saturday only \$1.

**\$1 pr.**

**BIG CLEARANCE SHOES** for all the FAMILY:

On Sale Friday Morning  
Budget Basement

**\$1.00 pr.**

This will be the big scramble Friday and Saturday. All kinds of odd lot shoes for the entire family. Don't expect a sales person to give you fitting service. You will have to dig for yourself. Real bargain. Hurry for best selection.

Budget Basement

One Big Rack

## Wash DRESSES

**\$1.00**

Here is a rack of fast color cotton wash dresses. Every dress made to sell for \$1.98. Sizes 12 to 20. Hurry.

Bamboo

## Cafe Curtains

**\$1.00** each panel

Here are those popular bamboo Cafe curtains. They are ready to hang. Take a look at this low price of \$1.00 per panel. Buy as many as you need.

SHOP SATURDAY NIGHT TIL 9:00

Men's

## Stretch Socks

Here are the miracle stretch socks for men. Yes, one size fits all. A big showing of the new styles.

**2 pr. \$1**

**Larson's**  
LARSON KUHN CO

The Wayne Herald
Serving Northeast Nebraska's Great Farming Area
110 Main St. Wayne, Nebr. Phone 130

Established in 1875; a newspaper published weekly on Thursdays by Mrs. Margaret E. Craney; entered in the postoffice at Wayne, Nebraska, as second class mail matter. Copy must be submitted by Tuesday afternoon.

Bob Johnson editor
Bill Richardson business manager

MEMBER NEBRASKA PRESS ASSOCIATION
NATIONAL EDITORIAL ASSOCIATION AFFILIATE MEMBER

Copyright 1955 by The Wayne Herald, Bob Johnson, editor. Reproduction in whole or in part strictly forbidden without written consent of The Wayne Herald.

Official Newspaper of the City of Wayne, the County of Wayne and the State of Nebraska

SUBSCRIPTION RATES
In Wayne, Pierce, Cedar, Dixon, Thurston, Cumming, Stanton and Madison counties: \$3.00 per year, \$2.00 for six months, \$1.00 for three months. Outside counties mentioned: \$3.50 per year, \$2.50 for six months, \$1.25 for three months. Single copies 10c.

Gives You a Lift
For a mental lift we recommend a trip to the housing developments in Northeast Wayne.

The roar of machinery and trucks is punctuated by the rapping of carpenters' hammers, the whine of power saws, the clatter of lumber being unloaded and shouts of workmen.

Man and wife discuss house plans with contractors while engineers busily set transits and sight for water lines and new foundations.

If you're tired, have spring fever or feel everything is old stuff, take the trip during the day sometime soon. Makes you feel Wayne is a booming, bustling town that is really going places.

In Bookland
Mrs. F. A. Mildner
City Librarian

NATIONAL FAMILY WEEK IS CELEBRATED
this month (May 1 to 8) under auspices of the National Council of Churches of Christ.

CARHART'S - Home Improvement Headquarters
YOU CAN HAVE Garage PLUS Storage WITH ONLY TWO EXTRA FEET
SOMETHING NEW has been added to the old style garage!
EASY MONTHLY TERMS NO CASH DOWN AS LOW AS 1278 PER MONTH
CARHART LUMBER COMPANY
105 Main Phone 614 Wayne, Nebr.

DID YOU EVER STOP TO THINK THAT THE librarians often have less time to read than their many patrons who complain that they don't have enough time for books.

WE KNOW THERE ARE LOTS OF READERS using the Wayne library because we have just been working on our yearly statistics.

READING FOR THE SUMMER HAS BEEN ARRIVING in every mail. We tried to buy light fiction, mystery or adventure in larger quantities than usual.

Way Back When...
30 Years Ago
May 7, 1925: Some of the Wakefield high school men will enter the track meet in Wayne Friday of this week.

25 Years Ago
May 8, 1930: Fairacres Farm herd topped the Madison county Dairy Herd Improvement association with butterfat average of 48.1 and milk production average of 1,444 pounds.

20 Years Ago
May 9, 1935: Of the 136 eighth graders taking the Wayne county examinations in April, 106 passed the tests.

Lincoln The Legislature was wading through one tough bill after another this week as the date of final adjournment approached only about a month away.

Holmberg of Wakefield, formerly of Wayne, went to a town near Toronto, Canada, last week to receive care for rheumatism.

15 Years Ago
May 9, 1940: Two suits of clothes belonging to H. E. Siman and a mantle clock and radio belonging to Dr. C. A. McMaster are missing as the result of break-ins Saturday night.

HERE AND THERE...
With Your County Agent
By Harold Ingalls

Spray Fruit Trees
Now is the time to make arrangements for spraying your fruit trees for diseases, particularly cod apple rust, scale and brown rot.

Capon Production
Facts, not fancy, needs to be the basis for deciding whether to add capons to the farm poultry enterprise.

Alfalfa Cutting
A report on four years of experience with alfalfa cutting dates indicates early cutting does not pay.

pinch of property taxes enough. Interestingly enough, most of the votes for the sales-income tax bill came from senators from western Nebraska, which felt hardest the increased taxes on real estate that came from the 1953 statewide equalization effort.

Tax Defeat
One of the climactic occasions of the session came when the Legislature, by a decisive 28 to 12 margin, voted down a proposed sales and income tax, LB 510.

Buying a car?
MY BANK PLAN MAY SAVE YOU \$100 ON FINANCING AND AUTO INSURANCE
Frank Gilbert
Before you buy that car, just tell me on the phone the total costs of the car, the financing and the insurance.

by a jacket zipper while playing in the park. Wakefield city council met Tuesday evening to reorganize Wilbur Petersen is the newly elected mayor and took office. Fred Salmon and Dr. Max Coc are new members.

10 Years Ago
May 10, 1945: FIGHTING ENDS IN EUROPE - Victory Achieved Over Nazi Forces. Mrs. C. F. Maynard, the former Lelia Mitchell, will give the address for Wayne county 8th grade graduates at Wayne municipal auditorium Saturday, May 19.

Utility Appraisals
The Legislature Revenue committee pulled a surprise out of the bag in asking the Budget Committee to appropriate enough money to the State Tax Commission for a complete study of the appraisals of utilities.

School Lands
Sen. Bixler, 40-year-old legislator from the northwestern corner of the state, proved to be just about the busiest - and luckiest - man of the week.

Control Board
On the other hand, the Legislature refused to tamper with the State Board of Control system. Killed by a 21 to 19 vote was a constitutional amendment proposal for a popular vote in the 1956 general election on changing the system.

Ft. Robinson
The Harrison legislator was also able to get the Legislature to give initial approval to appropriating \$130,000 to turn old Fort Robinson in his corner of the state into a first class tourist attraction.

Wayne County Officials
Mayor Glenn Hundershohdt 231
City Treasurer Leslie W. Ellis 23-J
City Clerk Walter S. Bressler 298-J

Wayne County Officials
Assessor, Henry Arp 198
Clerk, C. A. Bard 38
Judge, David J. Hamer 258
Sheriff, Hans Tietgen 233

Wayne County Officials
Dahl Nursing Home
Home for the aged and convalescent
Clifford Dahl, owner and operator
918 Main St. Wayne, Nebr. Phone 18

Wayne County Officials
Cavanaugh
INSURANCE - REAL ESTATE
Phone 84

Wayne County Officials
Dahl Nursing Home
Home for the aged and convalescent
Clifford Dahl, owner and operator
918 Main St. Wayne, Nebr. Phone 18

Wayne County Officials
Cavanaugh
INSURANCE - REAL ESTATE
Phone 84

Trade at Home
All right! You don't have to be so beligerent about it. I admit I bought it out-of-town.
Won't you even look at it?
THIS AD SPONSORED IN COMMUNITY INTEREST BY THE WAYNE HERALD

4-H CLUB NEWS
Future Feeders
Last meeting of Future Feeders was held in the Glenn Magnuson home last Tuesday.

Turnpike Authority
The Legislature by a 25 to 13 vote abolished the two-year-old turnpike authority. Major argument was that the law establishing the authority gave it too many broad powers.

Wilbur
Mr. and Mrs. Lyle Cleveland and Sharon spent Sunday with Mrs. Cleveland's parents, Mr. and Mrs. C. H. Tuttle, Concord.

Mr. and Mrs. Harold Erdman and family went to Wynmore for the weekend to visit with his parents, Mr. and Mrs. Stieff Erdman, and other relatives.

Mr. and Mrs. Barney Waters and Mrs. Konrad Sandrock, all of Sioux City, visited a while last Sunday afternoon in the Oscar Thun home.

Mr. and Mrs. Oscar Thun and Mrs. Thun spent Tuesday evening with her brother, George Sandrock and family, Harrington.

Wayne County Officials
Mayor Glenn Hundershohdt 231
City Treasurer Leslie W. Ellis 23-J
City Clerk Walter S. Bressler 298-J

Wayne County Officials
Assessor, Henry Arp 198
Clerk, C. A. Bard 38
Judge, David J. Hamer 258

Wayne County Officials
Dahl Nursing Home
Home for the aged and convalescent
Clifford Dahl, owner and operator
918 Main St. Wayne, Nebr. Phone 18

Wayne County Officials
Cavanaugh
INSURANCE - REAL ESTATE
Phone 84

Wayne County Officials
Dahl Nursing Home
Home for the aged and convalescent
Clifford Dahl, owner and operator
918 Main St. Wayne, Nebr. Phone 18

Wayne County Officials
Cavanaugh
INSURANCE - REAL ESTATE
Phone 84

Business and Professional DIRECTORY

CHIROPRACTORS
Drs. Lewis & Lewis
ELECTRICIANS
Tiedtke Electric
NURSING HOMES
Dahl Nursing Home
REAL ESTATE
Cavanaugh
INSURANCE - REAL ESTATE
OPTOMETRISTS
W. A. Koeber, O.D.
SERVICES
Listing your profession in this directory assists others when needing your special services.







# Plan Baccalaureate Services Sunday Night at Auditorium

Winside high school baccalaureate services will be held at 8 p. m. Sunday in Winside auditorium. Supt. George Norris announced this week.

C. L. VanMetre, Methodist pastor, will deliver the sermon. Commencement exercises will be held Wednesday evening. Speaker will be C. Loyd Schubert, WSTC faculty member.

A class of 26 seniors will receive diplomas. Twelve eighth graders will also receive diplomas.

**Attend Forum**

Mr. and Mrs. H. J. Podoll attended a forum last Wednesday evening in Omaha featuring Dr. Norman Vincent Peale and Mildred Bennett, a sales specialist.

**Oregon Visitors**

Mr. and Mrs. Ernest Lehrer and Mr. and Mrs. Richard Lehrer, Portland, Ore., were guests at the Otto, Fred and Edvard Ulrich homes Tuesday and Wednesday. They also visited Mrs. Emma Ulrich, Norfolk. Ernest Lehrer is a nephew of Ulrichs.

**Attend Funeral**

Mr. and Mrs. Robert Matmborg and lady, Carroll, Mrs. Albert Lambrecht and Russell Matmborg, Norfolk, drove to Red Oak, Ia., Sunday where they attended funeral services Monday for their uncle, John Matmborg. The group returned home Monday evening.

**Surgery Patients**

Ruth Jensen, 13, daughter of Mr. and Mrs. Vernon Jensen, and Carol Kathy, 14, daughter of Mr. and Mrs. John Kahny, both underwent emergency appendectomies Friday in the Lutheran hospital at Norfolk. Both girls are reported good.

**Home from Hospital**

Mrs. Ken Benschhof returned from the Mayo clinic, Rochester, Minn., last Wednesday accompanied by Mr. Benschhof and Mrs. Otto Graef, who spent several days at Rochester. Mrs. Benschhof's condition is reported improved.

**Play in Revital**

Gaselle Podoll, daughter of Mr. and Mrs. Harvey Podoll, Corinne St. and Ruth Ann Troutman, daughters of Mr. and Mrs. James Troutman, and Junith and Sonia Thompson, daughters of Mr. and Mrs. Duane Thompson, were among students who played in a musical recital at WSTC Thursday evening.

**Attend Funeral**

Mr. and Mrs. Robert Matmborg and lady, Carroll, Mrs. Albert Lambrecht and Russell Matmborg, Norfolk, drove to Red Oak, Ia., Sunday where they attended funeral services Monday for their uncle, John Matmborg. The group returned home Monday evening.

**Name Heusinger As Memorial Day Speaker**

Rev. George Heusinger, pastor of Immanuel Reformed church, will be guest speaker at annual Memorial day services in Winside May 30.

He is also pastor of Peace Reformed and Reformed church near Norfolk.

Services are sponsored by Roy Reed American Legion post and Auxiliary. Public dinner will be served by the Auxiliary.

**Three-Fours Bridge Club**

Mrs. H. A. Hilpert served a dessert Friday for Three-Fours Bridge club at her home. Mrs. Vernon Hill was a guest of the club. Prizes went to Mrs. Otto Graef, Mrs. C. O. Witt, Mrs. Frank Weible and Mrs. Hill. The club will meet May 20 with Mrs. L. W. Kahl.

**St. Paul's Ladies' Aid**

The St. Paul's Lutheran Ladies and met last Wednesday afternoon in the church parlors with Mrs. William Loebbeck and Mrs. Werner Moen as hostesses. Thirty-three members were present. Guests were Mrs. Annie Selman, Los Angeles, and Mrs. John Asmus. Mrs. Ray Reeg had charge of the business session. Mrs. Carl Nieman and Mrs. Otto Carsten were named to serve at the snack bar at Norfolk Lutheran hospital Friday. Plans were discussed concerning the silver anniversary of the aid in September. Mrs. Adolph Miller and Mrs. Richard Miller entertained in June.

**Mr. and Mrs. Edwin Brogren** and daughters were among other guests in the Kennard Hall home Wednesday for Mr. Ball's birthday.

Mr. and Mrs. Carl Sundell, Wakefield, and Mrs. Elta Blodgett, Yankton, were Sunday visitors in the Fred Erickson home. Mrs. Blodgett remained to spend the week at the Erickson home.

Mr. and Mrs. W. F. Farnberg and Mr. and Mrs. Gene Behmer and daughters were Mother's Day dinner guests in the Glen Bowers home, Norfolk.

# WINSIDE NEWS

By Gladys Reichert, phone 2682

**Sunday dinner and luncheon** guests in the M. W. Kanner home were Mr. and Mrs. LeRoy Barner and family, Wayne, Mr. and Mrs. Clifford Baker and family and Mr. and Mrs. Bob Paul and family, Wakefield, and Shirley Barner, Omaha, who spent the weekend with her parents.

Mr. and Mrs. Paul Leiting and family spent Friday evening in the Edwin Brogren home.

Guests in the William Kahl home Sunday evening were Mr. and Mrs. Everett Witte and daughters, Mr. and Mrs. Emil Danberg, Mr. and Mrs. Paul Danberg and Bradley and Mr. and Mrs. Otto Kant and family.

Mr. and Mrs. W. F. Danberg were among guests in the LeRoy Heusinger home Thursday evening in honor of Mr. Herscheid's birthday.

**Mr. and Mrs. William Tietgen** and Lois were visitors in the Lester Frawitz home Wednesday evening.

Mr. and Mrs. John Ritze and family, Wayne, and Mr. and Mrs. Carl Ritze and Harold were Mother's Day dinner guests in the Norman Svensen home.

Mr. and Mrs. Wayne Imel spent Tuesday evening in the Howard Morris home.

Mother's Day dinner guests in the Norman Deek home were Mr. and Mrs. Wilmer Deek and family, Mr. and Mrs. William Deek, Stanton, Mr. and Mrs. J. C. Beeten and sons, Mr. and Mrs. John Duhanek and Mr. and Mrs. Raymond Duhanek and Kathy, Meadow Grove, and Mr. and Mrs. R. J. Browner, Norfolk.

Mr. and Mrs. A. C. Gabler, Long Beach, Calif., were supper guests in the C. L. Imel home Monday evening.

Mr. and Mrs. Julius Eckert and Peggy and Mr. and Mrs. Robert Graef spent Sunday evening in the Carl Enlers home visiting Mr. Eckert's mother, Mrs. Rosa Eckert.

**Churches**

**Methodist Church** (C. L. VanMetre, pastor) Sunday, May 15: Sunday school, 10 a. m.; morning worship and reception of membership class, "The Lion and The Lamb," 11.

**Immanuel Reformed Church** (George Heusinger, pastor) Sunday, May 15: Morning worship, 10 a. m.; Sunday school, 11 a. m.

**Trinity Lutheran Church** (M. W. Peterson, pastor) Thursday, May 12: Luther League, 8 p. m. No catechetical class Saturday. Sunday, May 15: Sunday school, 10 a. m.; worship service, 11 a. m.

**St. Paul's Evan. Lutheran Church** (H. M. Hilpert, pastor) Tuesday, May 12: Sunday school, 10 a. m.; meeting, 8 p. m. Saturday, May 13: No Saturday school, confirmation class, 1 p. m. Sunday, May 15: German service. Rev. H. A. Hilpert, 9:30 a. m.; late service and examination of confirmation class, 10:45. Class members are Louisa Asmus, Marie Bronzynski, Janice Brudigan, Kenneth and Mary Jaeger, Byron and Dennis Janke, Wendell Litengood, Juleen Miller, Dennis Rohde and Donna Stevens.

Fanny Selders, Wayne, spent the weekend with her parents, Mr. and Mrs. O. R. Selders.

Mr. and Mrs. Andrew Mann and family, Harold Darnell, Marvin Wittler and Mr. and Mrs. Carl Mann and Jean Marie, Hoskins, spent Sunday in the Rufus Mann home, Sioux City.

Mr. and Mrs. Ross Dorrance, Fairmont, Minn., came Monday to spend several days with Mr. Dorrance's sister, Mrs. Joy Podoll and the Harvey Podoll family.

Mr. and Mrs. P. C. Jensen and Jimmie were dinner guests Sunday in the Chester Wylie home. Mr. and Mrs. Lowell Baker and sons, Pender, were afternoon visitors.

Mr. and Mrs. Gene Behmer and girls were visitors in the Raymond Wittler home Tuesday evening.

Mr. and Mrs. Charles Emmett and Mrs. Henry Lautenbaugh, Sioux City, were Mother's Day dinner guests in the Mrs. John Loebbeck home.

More WINSIDE—page 7

**Birthdays Card Party**

Mr. and Mrs. Leo Voss entertained a group of relatives and friends Thursday evening in honor of Mr. Voss' birthday. Card prizes went to Mrs. George Voss and Margaret Voss.

The following were afternoon and luncheon guests in the Gus Hoffman home for Mother's Day: Mr. and Mrs. Meelin Pfeil, Norfolk, Mr. and Mrs. Russell Hoffman, Mr. and Mrs. Wilfred Miller and Rody and Mr. and Mrs. Bill Hoffman.

**Install Officers At Woman's Club Event Monday**

Winside Junior Woman's club installed new officers at its annual Mother's Day tea Monday evening at Trinity Lutheran church.

Installing officer was Retiring President Mrs. Duane Thompson. New officers are: Gladys Reichert, president; Mrs. Garland Robbins, vice president; Mrs. M. W. Peterson, secretary, and Mrs. Otto Graef, treasurer.

The latter was not present.

Mrs. Albert G. Carlson and her six-year-old piano pupil, Ruth Cook, Wayne, presented the program.

Members voted to have a float in the Old Settlers picnic parade. Named to the float committee were Mrs. Robbins, Mrs. James Troutman and Mrs. Rosemary Mintz.

Miss Reichert named the following new committees: Mrs. Carl Troutman, Mrs. George Norris and Mrs. Lloyd Behmer, September picnic roundup; Mrs. N. Ditman and club officers, program; and Mrs. Otto Carstens, club pianist.

In charge of Monday evening were Mrs. Peterson, Mrs. Norris, Mrs. Ottred Baueiter, Mrs. F. C. Witt, Mrs. Gus Nelson, Mrs. Thompson, Mrs. Frank Floer, Mrs. Robbins and Mrs. Ditman.

Mrs. Norris, Mrs. Baueiter and Mrs. Carstens served lunch.

Norma Floy Nielsen, Hoskins, spent Friday with her sister, Mrs. Howard Morris and family.

**Three-Fours Bridge Club**

Mrs. H. A. Hilpert served a dessert Friday for Three-Fours Bridge club at her home. Mrs. Vernon Hill was a guest of the club. Prizes went to Mrs. Otto Graef, Mrs. C. O. Witt, Mrs. Frank Weible and Mrs. Hill. The club will meet May 20 with Mrs. L. W. Kahl.

**St. Paul's Ladies' Aid**

The St. Paul's Lutheran Ladies and met last Wednesday afternoon in the church parlors with Mrs. William Loebbeck and Mrs. Werner Moen as hostesses. Thirty-three members were present. Guests were Mrs. Annie Selman, Los Angeles, and Mrs. John Asmus. Mrs. Ray Reeg had charge of the business session. Mrs. Carl Nieman and Mrs. Otto Carsten were named to serve at the snack bar at Norfolk Lutheran hospital Friday. Plans were discussed concerning the silver anniversary of the aid in September. Mrs. Adolph Miller and Mrs. Richard Miller entertained in June.

**Mr. and Mrs. Edwin Brogren** and daughters were among other guests in the Kennard Hall home Wednesday for Mr. Ball's birthday.

Mr. and Mrs. Carl Sundell, Wakefield, and Mrs. Elta Blodgett, Yankton, were Sunday visitors in the Fred Erickson home. Mrs. Blodgett remained to spend the week at the Erickson home.

Mr. and Mrs. W. F. Farnberg and Mr. and Mrs. Gene Behmer and daughters were Mother's Day dinner guests in the Glen Bowers home, Norfolk.

**Pierce County Farmers Mutual Insurance Company**

Your Northeast Nebraska Home Insurance Company

PROTECTION AGAINST LOSSES

Fire and Lightning Wind and Tornado

EXTENDED COVERAGE

On Town and Rural Property, Churches and Schools

Local Agent: MERLIN L. FEVERY, Wayne

Willard C. Watson, Secretary, Pierce, Nebr.

# Shop In Wayne Dollar Days

**11 DOLLAR DAYS SPECIALS**

at

**Coast-to-Coast**

YOU SAVE MOST AT COAST-TO-COAST

Sturdy 5-Tie House Brooms \$1

AUTO CUSHIONS \$1

PAINT SPECIALS

Interior Gloss, Semi-Gloss Reg. 1.49 Qt. \$1

Aluminum Water PITCHERS \$1

8-Cup Enamel PERCOLATORS \$1

SEAT COVER SALE

Save \$1 On Any Set

LOCALLY OWNED COAST-TO-COAST STORES NATIONALY ORGANIZED

217 Main M. D. Fisher, owner Phone 85

**MCDONALD'S**

**GALA FASHION-REVEALING! DRESS FESTIVAL!**

Breeze-cool, make-you-pretty cotton sheers!

Suds-loving beauties that need little care!

**8<sup>95</sup>**

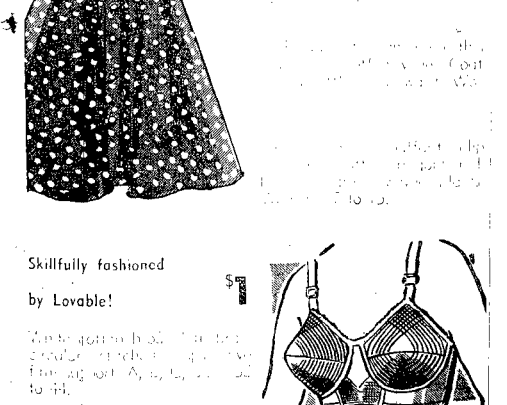

Skillfully fashioned by Lovable!

Cool, non-iron slips **398**

Shadow panel **298**

Non-iron petticoats **298**

Shadow panel **298**

Miss Elaine's sculptured, bat-trim petticoats made of combi-tized, white cotton. Lace trim. Women's 32-44.

**MCDONALD'S** gives you extra comfort, thrift

in your trim new **Straw**

Just like wearing a feather! Save!

**1<sup>98</sup>**

**2<sup>98</sup>**

**3<sup>98</sup>**

Breeze-cool beauties at easy-pay prices!

McDonald's proves you don't have to pay a fancy price for a good straw hat. We've mesh and linen weaves, plain and ventilated braids, fine Panamas and Honikis in styles just right for you. Charcoal grey, charcoal brown, natural, and sand. Bands are quiet or gay. Men's sizes. Made to take it!

LOOK YOUR HANDSOME BEST ON STRAW HAT DAY, MAY 14!

Balanced

Everything it takes to be "TOPS"

**STANDARD GASOLINES**

...balanced for top power, economy, and all 'round performance ... and raised to the Highest Octane levels in our history

We are mighty proud of our new gasolines. They have been stepped up to the highest octane ratings in our history. designed to give knock-free performance in the most modern of high compression engines, and older cars as well. But important as octane is, good gasolines need something more. They must be balanced too. STANDARD WHITE CROWN and RED CROWN Gasolines are balanced to give you top performance, with controlled volatility—the right gasoline for the right season—with no vapor lock even in the hottest summer weather. Try a tankful of one of these clean-burning, high octane, balanced gasolines today, and prove to yourself that there is a difference in gasolines.

Are all gasolines pretty much the same? NO, THEY'RE NOT. Standard's research brings you the best in gasolines. And we guard their quality from refinery to your car through exclusive terminals, lake tankers, river barges, pipelines, tank cars and trucks. No gasolines arrive at or go out of our terminals but Standard Gasolines. That's why they are distinctly different!

You expect more from **STANDARD** and get it!

**Standard Tank Wagon Service**

JIM POKETT Heating Fuel - Tractor Fuel - Gasoline PHONE 241-W

The Herald's Legal Section Complete Accurate Official FOR ALL WAYNE COUNTY

LEGAL PUBLICATION

CITY COUNCIL PROCEEDINGS

Board met per adjournment with all members present. Minutes of preceding meeting read and approved. Report of U. S. National Bank of Omaha shows a balance of \$50,000.00 to the credit of Wayne County Treasurer as of April 30, 1955. No other banks reporting.

Table with columns: General Fund, Income, Balance, and various entries like E. H. Gassman, E. H. Gassman, etc.

County Fund

Table with columns: Name, Amount, and entries like Evert Daler, Road work, August Brudigan, etc.

LEGAL PUBLICATION

NOTICE OF PROBATE OF FOREIGN WILL

In the County Court of Wayne County, Nebraska, Estate of Alva C. Garner, Deceased.

LEGAL PUBLICATION

NOTICE OF HEARING OF PETITION FOR FINAL SETTLEMENT OF ACCOUNT

In the County Court of Wayne County, Nebraska, Estate of Henry E. Floor, Deceased.

LEGAL PUBLICATION

NOTICE OF FINAL SETTLEMENT OF WAYNE COUNTY COURT OF WAYNE COUNTY, NEBRASKA

In the County Court of Wayne County, Nebraska, Estate of Alton R. Garner, Deceased.

LEGAL PUBLICATION

NOTICE OF HEARING OF PETITION FOR FINAL SETTLEMENT OF ACCOUNT

In the County Court of Wayne County, Nebraska, Estate of Alton R. Garner, Deceased.

LEGAL PUBLICATION

NOTICE OF HEARING OF PETITION FOR FINAL SETTLEMENT OF ACCOUNT

In the County Court of Wayne County, Nebraska, Estate of Alton R. Garner, Deceased.

LEGAL PUBLICATION

NOTICE OF HEARING OF PETITION FOR FINAL SETTLEMENT OF ACCOUNT

In the County Court of Wayne County, Nebraska, Estate of Alton R. Garner, Deceased.

Within County Lease Agreement was executed by the County Board at the County Court House of Wayne County, and that the same was signed by a majority of the members of said County Board.

Every government official or board that handles public money should publish at regular intervals an accounting of it showing where and how each dollar is spent.

LEGAL PUBLICATION

NOTICE OF PROBATE OF FOREIGN WILL

In the County Court of Wayne County, Nebraska, Estate of H. J. Felber, Deceased.

LEGAL PUBLICATION

NOTICE OF PROBATE OF FOREIGN WILL

In the County Court of Wayne County, Nebraska, Estate of Alva C. Garner, Deceased.

LEGAL PUBLICATION

NOTICE OF HEARING OF PETITION FOR FINAL SETTLEMENT OF ACCOUNT

In the County Court of Wayne County, Nebraska, Estate of Henry E. Floor, Deceased.

LEGAL PUBLICATION

NOTICE OF HEARING OF PETITION FOR FINAL SETTLEMENT OF ACCOUNT

In the County Court of Wayne County, Nebraska, Estate of Alton R. Garner, Deceased.

LEGAL PUBLICATION

NOTICE OF HEARING OF PETITION FOR FINAL SETTLEMENT OF ACCOUNT

In the County Court of Wayne County, Nebraska, Estate of Alton R. Garner, Deceased.

LEGAL PUBLICATION

NOTICE OF HEARING OF PETITION FOR FINAL SETTLEMENT OF ACCOUNT

In the County Court of Wayne County, Nebraska, Estate of Alton R. Garner, Deceased.

LEGAL PUBLICATION

NOTICE OF HEARING OF PETITION FOR FINAL SETTLEMENT OF ACCOUNT

In the County Court of Wayne County, Nebraska, Estate of Alton R. Garner, Deceased.

LEGAL PUBLICATION

NOTICE OF HEARING OF PETITION FOR FINAL SETTLEMENT OF ACCOUNT

In the County Court of Wayne County, Nebraska, Estate of Alton R. Garner, Deceased.

LEGAL PUBLICATION

NOTICE OF HEARING OF PETITION FOR FINAL SETTLEMENT OF ACCOUNT

In the County Court of Wayne County, Nebraska, Estate of Alton R. Garner, Deceased.

with the undersigned, County Superintendent, on April 15, 1955, said petitioners having been signed by more than 55% of the legal voters of each of said districts having been duly certified by the undersigned County Superintendent and approved by the State Committee of Organization on April 15, 1955.

Carroll

By Mrs. Fred Baird Phone 1 on 19 (Continued from Page 3)

Four Rural Schools Holds Closing Picnic

Several local rural schools have held their closing day picnics recently. District 46 had theirs at the schoolhouse last Sunday. School closed Tuesday. Patty Maas is teacher.

Carroll

By Mrs. Fred Baird Phone 1 on 19 (Continued from Page 3)

Four Rural Schools Holds Closing Picnic

Several local rural schools have held their closing day picnics recently. District 46 had theirs at the schoolhouse last Sunday. School closed Tuesday. Patty Maas is teacher.

Carroll

By Mrs. Fred Baird Phone 1 on 19 (Continued from Page 3)

Four Rural Schools Holds Closing Picnic

Several local rural schools have held their closing day picnics recently. District 46 had theirs at the schoolhouse last Sunday. School closed Tuesday. Patty Maas is teacher.

Carroll

By Mrs. Fred Baird Phone 1 on 19 (Continued from Page 3)

Four Rural Schools Holds Closing Picnic

Several local rural schools have held their closing day picnics recently. District 46 had theirs at the schoolhouse last Sunday. School closed Tuesday. Patty Maas is teacher.

Carroll

By Mrs. Fred Baird Phone 1 on 19 (Continued from Page 3)

Four Rural Schools Holds Closing Picnic

Several local rural schools have held their closing day picnics recently. District 46 had theirs at the schoolhouse last Sunday. School closed Tuesday. Patty Maas is teacher.

Carroll

By Mrs. Fred Baird Phone 1 on 19 (Continued from Page 3)

Four Rural Schools Holds Closing Picnic

Several local rural schools have held their closing day picnics recently. District 46 had theirs at the schoolhouse last Sunday. School closed Tuesday. Patty Maas is teacher.

Carroll

By Mrs. Fred Baird Phone 1 on 19 (Continued from Page 3)

Four Rural Schools Holds Closing Picnic

Several local rural schools have held their closing day picnics recently. District 46 had theirs at the schoolhouse last Sunday. School closed Tuesday. Patty Maas is teacher.

Carroll

By Mrs. Fred Baird Phone 1 on 19 (Continued from Page 3)

Four Rural Schools Holds Closing Picnic

Several local rural schools have held their closing day picnics recently. District 46 had theirs at the schoolhouse last Sunday. School closed Tuesday. Patty Maas is teacher.

Advertisement for Sherwin-Williams SWP House Paint, featuring an image of a paint can and the text 'Shop in Wayne Dollar Days'.

It pays to be "choosy" when you select house paint. Whether you employ a painting contractor or not, the price difference between famous SWP House Paint and ordinary house paint means less than \$5.00 for the average house job.

Continuous research has insured constant improvement and top-quality performance of SWP. You'll be money ahead when you discover there is a difference in house paints!

Advertisement for Sherwin-Williams Porch and Floor Enamel, featuring an image of a paint can and the text 'FREE!—44-page Home Decorator contains full facts on SWP House Paint...'.

Advertisement for Fullerton Lumber Company, featuring an image of a building and the text '113 S. Main Dave Theophilus, Mgr. Wayne'.

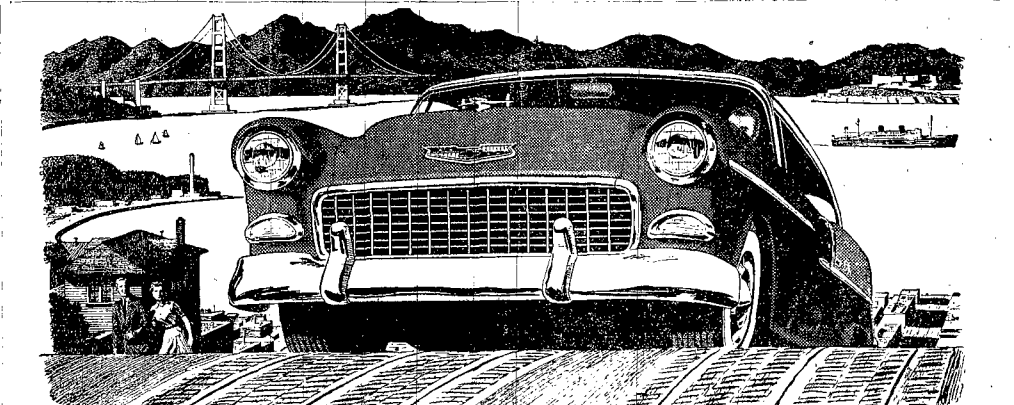

Punch-line to the year's hottest power story—Chevrolet Turbo-Fire V8!

This is the engine that's writing a whole new chapter in the book of automobile performance records. This is the engine that has stock car timers doing a "double take" at their stop-watches wherever experts gather to compare the abilities of the 1955 cars.

Advertisement for Coryell Auto Company, featuring an image of a checkered flag and the text '112 East 2nd Wayne, Nebraska Telephone 152'.

Large advertisement for Wayne Air Service, featuring the text 'NEW for WAYNE Air Ambulance Service' and 'CHARTER SERVICE'.

By Gladys Reichert  
P.O. Box 2682, Winside  
(Continued from Page Five)

Senior Girls  
Feted by Woman's  
Club Monday

Senior girls were guests at the Monday evening at St. Paul's Lutheran church parlors. They included Janet Petersen, Lorraine Swanson, Grete Iversen, Signe Nielsen, Junith Thompson, Jeanne Bruggen, Bonnell Peters, Lela Kay Hamilton and Lorraine Heier.

Other guests were Connie Sue Proulx, Sonja Thompson, Mrs. H. M. Hilbert, Annie and Anna Carlson, Mrs. Carl Nelson and Mrs. Carl Nieman.

The program included a piano solo by Miss Tronkman, a vocal solo by Junith Thompson, piano solo by Sonja Thompson, accordion solo by Miss Bruggen and a vocal number by the senior girls.

Mr. and Mrs. Andrew Mann and family spent Friday evening in the P. F. Marz home.

Mr. and Mrs. Willis Ritze and sons, Hoskins, were Sunday evening visitors in the Carl Ritze home.

Mr. and Mrs. Carl Sundell, Wakefield, spent Thursday in the Fred Erickson home.

Mr. and Mrs. A. C. Gabler, Long Beach, Calif., were in Stanton Saturday to visit in the Eli Best home.

Mother's Day dinner guests in the Artie Fisher home were Mr. and Mrs. Henry Wacker and family, Wayne, Mr. and Mrs. Don Fisher and family, Norfolk, and Mr. and Mrs. Norman Christensen and family, Stanton.

Mr. and Mrs. Howard Iversen and family, Mrs. Anna Andersen and Mr. and Mrs. Andrew Andersen were supper guests in the Marvin and Leonard Andersen home last Sunday.

Circle Plans Shower For Margaret Voss

Neighboring Circle met Thursday afternoon with Anna Carstens. Roll call, an exchange of flower seeds and bulbs, was answered by 14 members. Guests were Anna Koll and Ethel Carstens. Miss Koll became a member.

At the business session members planned to sponsor a bridal shower for Margaret Voss. No definite date was decided upon.

Mrs. George Coulter had charge of the entertainment with Mrs. Ernest Muehlmeier, Mrs. Anderson and Mrs. Deck winning prizes in contests.

Mr. and Mrs. Julius Eckert and Peggy were Mother's Day dinner and luncheon guests in the Robert Grief home.

Mr. and Mrs. Gilbert Dangberg and family and Mr. and Mrs. Gene Behmer and daughters were Sunday evening visitors in the W. F. Dangberg home.

Mrs. Helen Martin and children, Lattiel, were Sunday afternoon luncheon guests in the Howard Iversen home.

Mr. and Mrs. Bernard Jensen and family, Pilger, and Mr. and Mrs. Willis Ritze and sons, Hoskins, were Mother's Day dinner guests in the Krist Jensen home.

Mr. and Mrs. Artie Fisher entertained the following guests at supper Monday evening: Mr. and Mrs. Hiram Wilson, Mr. and Mrs. Harold Quinn and Mr. and Mrs. Henry Warnum.

Mrs. H. C. Hanson spent Friday in Norfolk and was dinner guests in the A. A. Rissoe home.

109 at Trinity Mother-Daughter Event Thursday

About 110 guests attended the annual mother-daughter banquet at Trinity Lutheran church Thursday evening. Church Brotherhood sponsored the event and prepared the meal.

Mrs. Lloyd Behmer acted as toastmistress. Mrs. Jack Krueger played an organ prelude. She and her daughter, Sharolyn, led the prayer.

A girls' chorus composed of Maxine Thies, Grete Iversen, Lydaisy and Georgiana Mann and Marilyn Monk sang. Mrs. E. T. Warnumde played the accompaniment. Miss Iversen gave a reading. Dickie Gillespie sang a solo.

Rev. Roy Wagnor, pastor of St. John's Lutheran church, Schuyler, was guest speaker. Mrs. Emil Thies and Maxine had the benediction.

Decorated plants and corsages were presented to the following: Mrs. Wilbur Gaebler, oldest mother present with her daughter; Mrs. Warren Jacobsen, youngest mother present with her daughter; Kathy Pfeiffer, youngest daughter, and Mrs. Andrew Mann, Lydaisy, Georgiana and Marilyn, youngest mother-daughter group present.

ERASING THE BLACKBOARD

At The Wayne County Schools

Wayne High...

Kindergarten We enjoyed giving our Play Day program on Monday for the lower grades and again on Tuesday afternoon. We had a large crowd of parents and friends and were glad to meet boys and girls of next year's class.

Friday we each took home to our mothers a small potted plant we had wrapped in pretty paper, as our gift for Mother's Day.

Second Grade The second grade attended a dress rehearsal of the kindergarten play day Monday morning.

Third Grade Jim Mayhew celebrated his ninth birthday with a party at school on Thursday. He brought treats for the class.

Fourth Grade Many pupils brought May Day treats to school Monday.

Mrs. Echtenkamp brought treats to the pupils Wednesday afternoon for Donna's birthday.

Eight pupils received a perfect score in this week's spelling test. Those having perfect attendance this term are: Donna Echtenkamp, Judith Fork, Gene Kay, Jane Melior, Dale Morey, Gerald Schmoor and Dean Weible.

Mr. and Mrs. Stanley and family spent last Sunday afternoon at Maurice Stalnakers, Norfolk. Last Monday evening they visited Melvin Froelichs and Tuesday they were guests of Marvin Kramers, Winside.

Supper guests last Wednesday evening in the Wilbur Bruns home were Mr. and Mrs. Bill Fredrickson, Mr. and Mrs. Bill Carlson and family and Mr. and Mrs. Bill Nelson and family.

Mr. and Mrs. Frank Lindsay and Bryce were Sunday dinner guests of Walter Hamm, Winside. Others there were Mr. and Mrs. Ben Hamm, Osmond, Frank Hamm and parents of Mrs. Lindsay.

Mr. and Mrs. Edwain Brogren, Yvonne and Lois, Mr. and Mrs. Ed Shellenberg and Mr. and Mrs. Dallas Shellenberg and family were supper guests in the Harlan Herbolzheimer home near Pierce Sunday.

Mr. and Mrs. W. L. Cary were weekend guests of their son-in-law and daughter, Mr. and Mrs. Oscar Fiene and family, Lincoln, Michael and Kathryn Fiene accompanied their grandparents home for a visit.

Mr. and Mrs. Leslie Allemen and family and Mrs. August Allemen were Sunday evening visitors in the John Asmus home.

Mr. and Mrs. Carl Sundell, Wakefield, spent Thursday in the Fred Erickson home.

Mr. and Mrs. Edwain Brogren, Yvonne and Lois, Mr. and Mrs. Ed Shellenberg and Mr. and Mrs. Dallas Shellenberg and family were supper guests in the Harlan Herbolzheimer home near Pierce Sunday.

Mr. and Mrs. W. L. Cary were weekend guests of their son-in-law and daughter, Mr. and Mrs. Oscar Fiene and family, Lincoln, Michael and Kathryn Fiene accompanied their grandparents home for a visit.

Mr. and Mrs. Leslie Allemen and family and Mrs. August Allemen were Sunday evening visitors in the John Asmus home.

Mother's Day cards were made during art period. Our art exhibit has been mounted and classified. Tests were given in arithmetic, history and geography the past week.

This week's spelling, 100 per cent are Patsy Anderson, Buddy Bornhoff, Sid, de'rees, Judy Florine, Patty Hofeldt, Karen Johanson, Michael Karel, Irene Marra, Glen Morey, Lorraine Morris, Gary Nelson, Phil Pierson, and Barbara Wolske.

Mr. and Mrs. Stanley and family spent last Sunday afternoon at Maurice Stalnakers, Norfolk. Last Monday evening they visited Melvin Froelichs and Tuesday they were guests of Marvin Kramers, Winside.

Supper guests last Wednesday evening in the Wilbur Bruns home were Mr. and Mrs. Bill Fredrickson, Mr. and Mrs. Bill Carlson and family and Mr. and Mrs. Bill Nelson and family.

Mr. and Mrs. Frank Lindsay and Bryce were Sunday dinner guests of Walter Hamm, Winside. Others there were Mr. and Mrs. Ben Hamm, Osmond, Frank Hamm and parents of Mrs. Lindsay.

Mr. and Mrs. Edwain Brogren, Yvonne and Lois, Mr. and Mrs. Ed Shellenberg and Mr. and Mrs. Dallas Shellenberg and family were supper guests in the Harlan Herbolzheimer home near Pierce Sunday.

Mr. and Mrs. W. L. Cary were weekend guests of their son-in-law and daughter, Mr. and Mrs. Oscar Fiene and family, Lincoln, Michael and Kathryn Fiene accompanied their grandparents home for a visit.

Mr. and Mrs. Leslie Allemen and family and Mrs. August Allemen were Sunday evening visitors in the John Asmus home.

Mr. and Mrs. Carl Sundell, Wakefield, spent Thursday in the Fred Erickson home.

Mr. and Mrs. Edwain Brogren, Yvonne and Lois, Mr. and Mrs. Ed Shellenberg and Mr. and Mrs. Dallas Shellenberg and family were supper guests in the Harlan Herbolzheimer home near Pierce Sunday.

Mr. and Mrs. W. L. Cary were weekend guests of their son-in-law and daughter, Mr. and Mrs. Oscar Fiene and family, Lincoln, Michael and Kathryn Fiene accompanied their grandparents home for a visit.

Mr. and Mrs. Leslie Allemen and family and Mrs. August Allemen were Sunday evening visitors in the John Asmus home.

Mr. and Mrs. Carl Sundell, Wakefield, spent Thursday in the Fred Erickson home.

Shop In Wayne Dollar Days

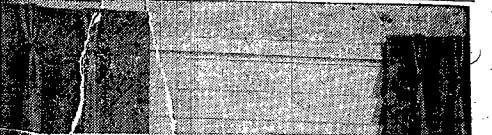

CUSTOM-MADE

DRAPERIES

The Largest Showing of

Fabrics

In Northeast Nebraska

At Only \$1.98 Yd. Up

We will show them to you Right in your home

Phone 56 for an appointment

No Job Too Big or Too Small For Us

Our Service is Complete

We measure and install at no extra cost

Free Decorating Service is Yours For the Asking

Ask for Free Estimate

Perfect Control of Light and Air At Your Fingertips. Includes illustration of a hand operating a window blind.

Larson's LARSON KUHN CO

Larson's LARSON KUHN CO

At Larson's Double Pleasure to buy your BIGELOW CARPETS

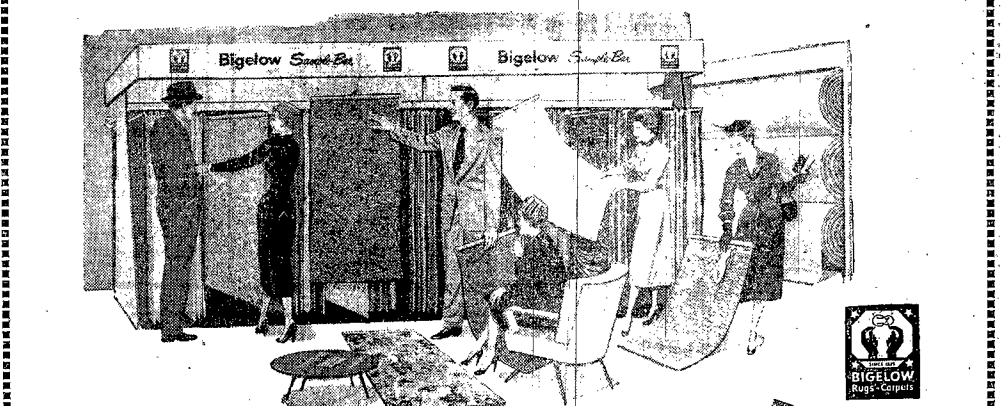

Selecting is so much fun... with our Bigelow Sample Bar. Now you can choose your carpet just as you shop for fashions...

Paying is so easy... with our Time Payment Plan. Now you can enjoy luxurious carpets on your floor while you are paying for them.

Larson's LARSON KUHN CO

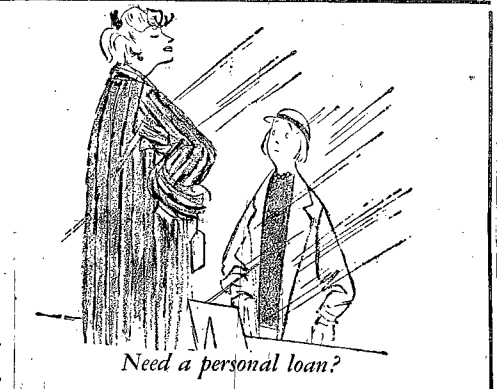

Need a personal loan? First National Bank 200 Main Phone 7

LOOK! Advanced Styling! Advanced Features! New Westinghouse Imperial 30 Range. Includes list of features and price \$249.95.

Super Corox, the speed unit. Clock and Timer. Color-Glance Controls. Includes illustration of the Corox range.

**Garment Bags**  
 Full length opening, washable, extra strong, mildew-proof, stain-proof, dust-proof, tear-resistant. Assorted colors.  
**\$1**

**McDONALD'S**  
 bargain-giving

# DOLLAR DAY

33 x 38 Bleached  
**Tea Towels**  
 Look at the large size. Washed and bleached.  
**4 for \$1**

**EVERY DOLLAR YOU SPEND BUYS SUPER VALUE! LOOK AT THESE!!**

13 x 18-inch  
**TV TRAYS**  
 Beautiful patterns, heavyweight, durable metal. Assorted colors.  
**2 for \$1**

**Ironing Board Pad and Cover**  
 Fits any standard ironing board. Packed in resealable plastic bag.  
**\$1**

**SEE HOW YOU SAVE!**

MEN'S UNDERSHIRTS Sizes 38-46	3	for	\$1
Large White HANDKERCHIEFS	10	for	\$1
Boys' BRIEFS Sizes 6-16	3	for	\$1
Infants' NYLON POLO SHIRTS Sizes 1-3	2	for	\$1
80-square UNBLEACHED MUSLIN	4	yds.	\$1
80-sq. PRINTED PILLOW CASES Assorted Colors	2	for	\$1

Buckskin  
**Leather Gloves**  
 Sizes S, M, L. First sell at \$2.75. These go for Dollar Days only at  
**\$1 pair**

Sew-Sew-Sew!  
**GINGHAMS**  
 Beautiful checks, large and small. Sanitized and vat dyed. Now only  
**2 yds. \$1**

60 x 76 White  
**Sheet Blankets**  
 First quality. Compare!  
  
**\$1**

51-gauge, 15-denier  
**NYLONS**  
 Sizes 8 1/2-11. Beigetone and taupe-tone colors. Now for Dollar Days.  
  
**2 pr. \$1**

**HERE'S REAL VALUE!**

BUTCHER LINEN—solid pastels	3	yds.	\$1
WASHABLE RAYON	4	for	\$1
GUEST SIZE TOWELS Heavyweight, assorted colors.	4	for	\$1
81 x 108 COLORED SHEETS	2	for	\$5
PILLOWS 50% goose, 50% duck feathers	2	for	\$5
WASH CLOTHS Large size, heavyweight	8	for	\$1
VENETIAN BLINDS 27, 28, 36-inch widths; 64-in. long	2	for	\$5

Boys' Guaranteed  
**Dress Socks**  
 Nylon heel and toe. Guaranteed 5 months wear or five new pair. Beautiful pink and black combinations.  
  
**5 pr. \$1**

Men's Sanitized  
**Work Shirts**  
 Chambray. Sizes 14-17  
  
**\$1**

81 x 108 Type 128  
**Bleached Sheets**  
 Limited quantity. Hurry in for these.  
  
**2 for \$3**

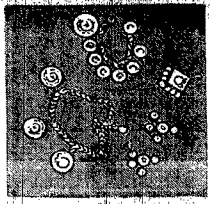
Beautiful  
**Costume Jewelry**  
 Earrings, necklaces, bracelets, pins, chokers. Values to \$2. Now 2 for only \$1 (plus tax)  
  
**2 for \$1**  
 (plus tax)

**CHECK THESE VALUES**

GIRLS' PLISSE BLOUSES S, M, L. Assorted Colors. Sleeveless	6	for	\$1
27 x 27 BIRDSEYE DIAPERS Easy to wash. Long wearing	6	for	\$1
WOMEN'S SLEEVELESS BLOUSES S, M, L. Assorted colors	6	for	\$1
41 x 84 READY-MADE DRAPES Gold and rose	3	pair	\$3
CHROMSPUN PRISCILLA CURTAINS 81 x 90 in. Limited quantity and colors	2	pair	\$2
Reg. 5.95 24x36 RUGS Taken from our regular stock for Dollar Days	2	for	\$3

Men's Combed  
**Cotton Briefs**  
 Durable, long wearing. Sizes 28-44. Now for Dollar Days  
  
**2 pr. \$1**

Boys' 8-oz.  
**Denim Jeans**  
 Sanitized. Sizes 4-12. Now for Dollar Days only  
  
**\$1 pr.**

Sew-Sew-Sew!  
**Yard Goods**  
 36-inches wide. Flannel, gingham, rayon, seining, percales. Dollar Days only.  
  
**3 yds. \$1**

100% Nylon  
**Women's Briefs**  
 Sizes 5, 6, 7. Assorted pastel colors. A real savings for this sale only.  
  
**2 pr. \$1**

Men's Nylon Neck  
**T-SHIRTS**  
 Sizes S, M, L. Combed cotton with Nylon neckband.  
  
**2 for \$1**

Men's Summerweight  
**Dress Shirts**  
 The nicest lightweight fabrics we've seen for some time. Assorted colors. Sizes 14 1/2-17.  
  
**2 for \$5**

Large Size  
**Bath Towels**  
 Extra thick, beautiful colors.  
**2 for \$1**

54 x 54 Sanitized  
**Lunch Cloths**  
 Vat dyed. Beautiful patterns and colors. Select now and save during Dollar Days.  
**2 for \$3**

Men's Random  
**Work Socks**  
 Full length. Sizes 10-12  
**5 pr. \$1**

Nylon or Cotton  
**BRASSIERES**  
 Reg. values to \$1.98. B cups, sizes 32-38. Now for Dollar Days only.  
**2 for \$1**

Children's Short Sleeve  
**POLO SHIRTS**  
 Sizes 3-6x. Pastel colors ideal for hot summer wear for dress or play.  
**3 for \$1**

Men's Gray  
**Work Uniforms**  
 Here's real savings for you during Dollar Days. Shirts 14-17 1/2; pants 28-44. Select now and save.  
**per set \$5**



Women's Beautiful  
**Rayon Night Gowns**  
 Assorted colors. Sizes S, M, L. Here's real value for your sleeping comfort. Beautiful rich colors. You'll want 2 or 3 at this price.  
**\$1**



Women's Cotton  
**BLOUSES**  
 Assorted colors. Sanitized. Sizes 32-38  
**\$1**

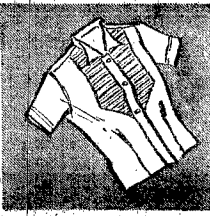

81-inch  
**Nylon Panels**  
 Here's real beauty. Limited quantity so you better hurry.  
**\$1**

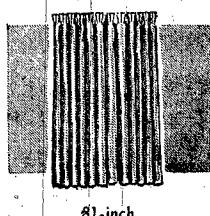

Beautiful 27x50  
**Loop Rugs**  
 Assorted colors. Washable.  
**2 for \$5**



Full Size Chenille  
**Bedspreads**  
 Assorted colors. Select now and save.  
**\$3**



Mrs. Ellis Johnson  
Phone Atlas 7-2346

Mr. and Mrs. Erick G. Johnson attended the organ recital at St. Paul's Lutheran church, Wayne, Sunday afternoon.

Mr. and Mrs. Charles Pierson were entertained at Sunday dinner in the Dean Pierson home, Wayne. They were coffee guests by the Carl Anderson home that evening.

Mr. and Mrs. Leonard Olson and Mrs. Emily Seagren were entertained at Sunday dinner in the Harold Olson home.

Mrs. Joe C. Johnson visited Mrs. Erick G. Johnson Thursday evening.

Mr. and Mrs. Harold Olson and daughters visited in the Charles Pierson home Tuesday evening and were Friday evening visitors in the Ernest Johnson home near Allen.

Mr. and Mrs. Carl Skoglund, Wauna, and Mrs. T. W. Wainling, Foster, were entertained at Sunday dinner in the Darwin Nimrod home. The last mentioned is Mrs. Nimrod's grandmother.

Ruth Nelson and Erma Zugschwerdt, Sioux City, were Saturday visitors in the Charles Pierson home.

Mrs. Harold Messerschmidt and Jon. San Mateo, Calif., were entertained at dinner in the Harold Olson home Thursday evening.

Mr. and Mrs. Francis Whitney and children, Coleridge, and Mr. and Mrs. Charles Fleetwood were entertained at Sunday dinner and supper in the Donald Fleetwood home.

Mr. and Mrs. Lenus Ring were Sunday evening visitors in the Phillip Ring home.

Mr. and Mrs. Waldo Rodene and daughters were Thursday evening visitors and Mr. and Mrs. Ernest Winegardner and children were Friday evening visitors in the Darwin Nimrod home.

Mr. and Mrs. R. A. Nimrod were entertained at Sunday dinner and lunch in the Ray Hallgren home. Darwin Nimrods joined them at lunch.

Mr. and Mrs. Cecil Rhodes and children were Friday evening visitors in the Ted Clapper home.

Mr. and Mrs. Ellis Johnson and Mrs. Lettie Harman visited Mrs. Carrie M. Lamb and Fred Lamb near Bassett Sunday afternoon.

Mr. and Mrs. Cecil Rhodes and family joined Mr. and Mrs. Walter Chinn, Mrs. Lydia Luschen, Jeanne Chinn and Francis Rhodes, Council Bluffs, as Sunday dinner guests in the Charles Keyser home near Allen.

Mr. and Mrs. Lester Fischer joined relatives for a picnic dinner Sunday at the Joe Larson home near Homer in observance of Mother's Day.

Mr. and Mrs. Verdell Lund and sons were Sunday dinner guests in the Ben Lund home. They were evening visitors in the John Hanson home.

Mr. and Mrs. Vern Carlson and family were Sunday afternoon visitors in the Mary Lund home and evening visitors in the A. W. Carlson home.

For Lester Fischer's birthday last Tuesday, the following were evening visitors and enjoyed a cooperative lunch: Mr. and Mrs. Joe Larson and family, Mr. and Mrs. Chris Miller and family and Mrs. Laura Miller, Homer, Mr. and Mrs. John Fischer and children, and Mrs. Harold Fischer and Mr. and Mrs. Harry Oak were Sunday dinner and supper guests in the John Hrickert home, South Sioux City. They were Thursday evening visitors in the Donald Kai home near Waterbury.

# THE WAYNE HERALD

Vol. 81 - No. 1

Wayne, Nebraska, Thursday, May 12, 1955

Sec. 3 - Pages 1 to 8

Mr. and Mrs. Clarence Bockenhauer, Roger and Keith were Monday evening visitors in the John Bockenhauer home.

Mr. and Mrs. Reuben Goldberg and JaNohn joined Mr. and Mrs. Henry Holmberg at Sunday dinner in the Martin Holmberg home.

Harry Gustafson, jr. visited Gary Burns Sunday.

Mr. and Mrs. Eldon McGuire and Patty accompanied Mr. and Mrs. Gene Paul to Columbus Wednesday evening to meet the latter's parents, Mr. and Mrs. Robert Smith on their return home from a visit in California.

Mr. and Mrs. Clarence Schlines, Myrna and Merle were entertained at Sunday dinner and lunch in the Fred Schlines home. They were evening visitors in the home of Mrs. Emma Lunz.

Mr. and Mrs. Nels Bjorklund were Sunday afternoon visitors with Hilda Lundstrom, Concord. They were Monday afternoon visitors and luncheon guests in the Seth Ossian home.

Mrs. Ellis Johnson visited classes at the Bell school Friday afternoon as a guest of Jean Hanson.

Mr. and Mrs. John Bockenhauer, Lytle and Dean joined Mr. and Mrs. Forrest Hansen and Orlean, Okla., as Sunday dinner guests of Mrs. Helen Anderson and Mrs. Rose Utemark in observance of Mother's Day. The Bockenhauer family joined relatives at cooperative supper in the Weldon Mortenson home.

Mr. and Mrs. Cornelius Leonard attended the Guy Lombardo show in Norfolk last Monday evening. Ann and Susan spent the evening with their aunt, Mrs. Ray Wagner, Norfolk.

**Attend Aid Meeting**  
Mrs. Lloyd Hugelman, Mrs. Cornelius Leonard, Mrs. Agnes Leonard, Mrs. W. D. Hyde, Mrs. James Leonard and Mrs. Robert Leonard attended Pleasant Valley Aid Wednesday when they were guests of Olga and Alice Clauson, Norfolk. Plans were made for guest day June 1 in the Thurston Methodist church.

Mr. and Mrs. Walter Johnson, Sheryl and Kurt were Sunday dinner guests in the John N. Johnson home. They were evening visitors in the Elwood Sampson home with Mrs. Henry Hinnerichs, Wayne.

The Eldon McGuire, Wesley Carder and Albert Jepsen families picnicked at Crystal Lake Sunday.

Mr. Driskell was a Monday overnight visitor with Sheryl Johnson.

Mr. and Mrs. A. W. Carlson visited Mrs. Anna Temple and Mrs. Alex Carlson Sunday afternoon.

Mr. and Mrs. Marvin Mortenson and daughters and Erwin Mortenson were entertained at Sunday dinner in the Merlyn Holm home for Mother's Day.

Mr. and Mrs. Will Hugelman and houseguest, Mrs. L. V. Ackerman, were Thursday evening dinner guests in the Lloyd Hugelman home. Mr. and Mrs. Chris Neu were evening visitors.

Mrs. Russell Harrison and Tom were Friday evening visitors in the Ted Harrison home.

Mr. and Mrs. Walter Otte and Sandy were Sunday dinner and supper guests in the Will Evans home, Neligh.

The John Bockenhauer family were Friday evening visitors in the Clarence Schlines home.

Mr. and Mrs. Quinten Erwin and family, Concord, were Wednesday evening visitors in the Walter Johnson home.

Mr. and Mrs. Bob Fredrickson, Kay and Kevin were Sunday dinner guests in the Joe Carr home, Allen.

The Clarence Schlines and Hans Stark families were Tuesday evening visitors in the Fred Schlines home for the latter's birthday.

Mr. and Mrs. Harry Wert were Wednesday evening visitors in the Nels Bjorklund home.

Mrs. Ada McCorkindale was a Sunday dinner and supper guest in the Wilton McCorkindale home.

Mr. and Mrs. Ted Harrison were Sunday dinner guests in the Russell Harrison home. All visited Mrs. Bill Harrison and baby, Daryl Gene, at Bentback hospital Sunday afternoon.

Mr. and Mrs. Bernard Kinney and family had dinner with Mrs. Anna Shearer Sunday.

Mrs. L. V. Ackerman, Klamath Falls, Ore., Mrs. Will Hugelman and Mrs. Lloyd Hugelman were entertained in the home of Mrs. Ada McCorkindale Monday afternoon.

Mrs. Harley Bard, Roxann and Danny and Mrs. James Leonard were Tuesday forenoon visitors with Mrs. Lloyd Hugelman.

Ed Kinney, Ainsworth, was a Thursday overnight visitor in the Bernard Kinney home.

Mrs. Paul Everingham, Mrs. Bernard Kinney, Mrs. Ted Harrison, Mrs. Walter Otte and Mrs. Cecil Rhodes were among Serve-

All club members attending the extension club tea at Wayne Tuesday afternoon.

Mr. and Mrs. Dale Kinney were Wednesday evening visitors in the Walter Otte home.

Mr. and Mrs. Cornelius Leonard, Ann and Susan enjoyed cooperative dinner with the Leonard Schultz family, Norfolk, in the John Lettman home near Winside Sunday in observance of Mother's Day.

**Sholes**  
By Mrs. Martin Madsen  
Phone 48-R14, Randolph

Mother's Day guests in the Thomas Craven home were Mr. and Mrs. Ted Averill and Eddie Wisner, Mr. and Mrs. Ray Craven and family, Randolph, and Mr. and Mrs. Al Thoen and family and Mrs. Ted Sheehy and Tim, Omaha, Mrs. Charley Craven and Mrs. John Schrad, Randolph, called in the afternoon.

Mr. and Mrs. Julius Oberbering and children were Sunday dinner guests in the Joe Hinkle home.

Mr. and Mrs. Charles Junck, jr. and sons and Mr. and Mrs. Leonard Guinn and daughter, Norfolk, were Saturday evening guests in the Roley Isom home.

Mrs. Louisa Gubbels, her son and daughter, Atlantic, Ia., were Saturday night and Sunday morning guests in the Walter Gubbels home. Donna Mae Gubbels, Wayne, spent Saturday until Monday in the Gubbels home.

Monday evening visitors in the Marlin Bauer home were Mrs.

Bauer's parents, Mr. and Mrs. Emil Schuitz and Leary, Pierce, Tuesday evening callers in the Bauer home were Mr. and Mrs. Art Watter and family, Randolph, Mr. and Mrs. Ludwig Kuhl and Mrs. Ed Bauer were Mother's Day dinner guests in the Don Bauer home.

Mr. and Mrs. Martin Madsen were Sunday evening dinner guests in the Everett Robins home, Hartington.

Mr. and Mrs. Roley Isom and family and their three married daughters and their families attended a picnic at Gibman's park near Pierce in observance of Mrs. Isom's father's eightieth birthday. There were 97 in attendance. Joseph Silhacek, Mrs. Isom's father, returned home with them to spend some time in the Isom home.

Mr. and Mrs. Marlin Bauer and son were Thursday evening supper guests in the Gaylord Martindale home, Randolph. Mr. and Mrs. Marlin Bauer went fishing Sunday

with Mr. and Mrs. Martindale. They reported fairly good fishing.

Mr. and Mrs. V. G. McFadden were Sunday dinner guests in the Lloyd McFadden home northwest of Randolph.

**Altona**  
By Staff Correspondent

Mr. and Mrs. Otto Miller, Mr. and Mrs. Emil Bargholz, Mr. and Mrs. Rueben Field and family and Mr. Otto Field and family were last Sunday dinner guests of Walter Reegs.

Mrs. Walter Reeg underwent major surgery Thursday morning at Wayne.

Dinner guests in the Leland Anderson home were Mrs. Louis Wink, Correctionville, Ia., and Mrs. Fred Pettett and children and Mr. and Mrs. Don Anderson, all of Norfolk.

# Keep A Cool Head WEAR A STRAW!

BY PROCLAMATION OF THE MAYOR

## Day Is SATURDAY

Why Melt In A Felt - Get A Cool Straw!



Meet Wayne's Friendly Straw Hat dealers: left to right Milt Mason and Don Echtenkamp, McDonald's; Paul Peterson, Larson's Clothing, and Bob McLean, Swans' Clothing.

You'll find them ready and willing to serve you SATURDAY on STRAW HAT DAY.



### Mayor's Proclamation

WHEREAS: The past winter has been cold, bleak and damp, and

WHEREAS: The male citizens of Wayne and the surrounding territory have during all of said winter gone about their affairs wearing hats adapted for the purpose of keeping heads and or ears protected from the ravages of the winter weather, and

WHEREAS: Said hats are now winter-weary, and

WHEREAS: Under such conditions the only proper attire for sweating male brows is lightweight hats made for and composed of straw or similar substance.

NOW THEREFORE: By the authority vested in me as the Mayor of the City of Wayne, I do hereby

PROCLAIM AND DECLARE: Saturday, the 14th day of May, 1955, is designated as STRAW HAT DAY and that on after said day, during the spring and summer months, it shall be fitting, proper, desirable and expedient that the male citizens of Wayne be encouraged to wear hats made of straw or similar substance.

Given by my hand this 12th day of May, 1955.

(signed) Glen Houdersheldt  
Mayor, City of Wayne

**LARSON'S**  
CLOTHING STORE  
GOOD CLOTHES FOR MEN AND BOYS

**SWANS'**  
CLOTHING  
FOR MEN AND BOYS

**McDONALD'S**

# WAKEFIELD Baccalaureate Services Set Sunday at Wakefield School

Rev. Ronald Buskirk will be guest speaker at the annual Wakefield high school baccalaureate services Sunday night at the school auditorium. His topic will be "Two-Talented People." The services will start at 8 p. m. Rev. Martin Wright will give the invocation and Rev. C. Willard Carlson the benediction. Mary Jane Coe will play the processional. The mixed chorus will sing "City God and I" and "Battle Hymn of the Republic." Commencement exercises are scheduled for May 20 for the 32 graduating seniors. Guest speaker will be Dr. Charles Mason, pastor of Sioux City First Methodist church. Principal Byron McCaughey will present awards and scholarships. Super Raymond Richards will present the class to Harry Larson, school board president, who will award diplomas. Miss Coe will play the processional and recessional. A boys' quartet and a girls' trio will sing.

Rev. Melvin O. Pederson will give the invocation and benediction.

**Leave for Oklahoma**  
Lt. and Mrs. Ralph Conner left Friday after a week's visit in the Mrs. Eva Conner home for his new station at Enid, Okla.

**Birth**  
Mr. and Mrs. Roy Wiggins received word last week of the birth of a daughter to Alice and Mrs. Dale Hollman at Turlock, Calif. Mrs. Hollman is the former Roberta Wiggins. Mrs. Wiggins left Fremont Monday morning to visit in California with the Hollmans.

**Leave for Laredo**  
Lt. and Mrs. Richard Pospisil left Saturday for Laredo, Tex. after a three-week visit in Wakefield. Mr. and Mrs. A. L. Pospisil accompanied them as far as Crete where they spent the weekend with

Mr. Pospisil's sister, Mrs. A. B. Sobotka and husband.

**Visit in Ashland**  
Mr. and Mrs. Walter Moller were in Ashland Sunday, guests in the Harvey Hoffman home. Mrs. Anna Moller, who has been visiting in Ashland, returned home with them.

## Junior-Senior Banquet, Party Held Here Friday

Annual Wakefield high school junior-senior banquet was held Friday evening in the school auditorium. Four local churches, Mission Covenant, Christian, Salem Lutheran and Presbyterian, sponsored a party at Salem church following the banquet.

Banquet theme was "Evening in Paris." Decorations represented a french sidewalk cafe with small tables set under gay striped awnings.

Arlene Greve was toastmistress and gave the welcome. Tom Borg responded. Gus Hinrich commented on the future of the seniors. Glenn Conner gave the farewell to seniors. Patty Brudwig sang a solo.

Six sophomore girls dressed as ballet dancers were waitresses. They were Sharon Johnson, Jolene Peterson, Nettie Longe, Judy Graffis and Shirley Stolle. Sophomore boys as waiters were Sandy Otte, Kenneth McGustan, Dennis Fredrickson, Randall Blatter, Bill Larson and Donald Lloyd.

Junior mothers set the banquet. A carnival theme was carried out at the church party.

## Society ...

**Eastern Star**  
Eastern Star met Tuesday evening with Worthy Matron Mrs. M. C. Ralston presiding. Plans were made for the grand chapter convention which opened in Fremont Tuesday. Hostesses were Mrs. Kenneth Schroeder and Mrs. John Hanson.

**PEO**  
PEO met Monday evening with Vena Green, Mrs. Mauritz Carlson and Mrs. Lona Brit gave reports of the state convention they attended in Lincoln last week.

**St. John's Aid**  
St. John Lutheran aid met Friday afternoon in the church parlors. Hostesses were Mrs. Clarence Wolter, Olga Walters and Mrs. George Anderson. Bible study was conducted by Rev. Meske. Mrs. Oscar Becker, sr., conducted the business session. A Mother's Day program was given. It included a vocal solo by Mrs. Clarence Wolter, an exercise by six children and a reading by Mrs. Delbert Jensen. Mrs. Lawrence Johnson and Mrs. Ronald Ellis had the program.

**Attend Breakfast**  
Mrs. John Schroeder, Mrs. Gordon Bressler, Mrs. Ernest Winegardner, Mrs. J. H. Montgomery, Mrs. Dora Moad, Mrs. Ed Schmasse, Mrs. Dallas Wadot, Mrs. R. E. Paulson and Mrs. Ted Jones attended a breakfast at the Emerson Presbyterian church Friday morning. It was sponsored by Emerson Women's club and served by Emerson Presbyterian ladies. The following were Mother's Day guests in the Oscar Becker, sr. home: Mr. and Mrs. George Anderson and family, Mr. and Mrs. Clair Walters, Sioux City, Mr. and Mrs. Oscar Becker, jr., Luro and Roger, Mr. and Mrs. Charles Peters and Kevin, Mr. and Mrs. Kenneth Turner and family and Mr. and Mrs. Gerald Becker and David.

**Salem Dorcas**  
Salem Dorcas Society met in the church Thursday. Mrs. Burnell Grose conducted the business meeting. Devotions were led by Mrs.

## HERE'S HOW ... MAKE A HI-FI PLAYER CABINET

A cabinet for the high fidelity set is a project for the skilled home craftsman. It provides space for the amplifier, below; the tuner, center; and the record player in the top. Top, end, and door panels are edge-glued 3/4-inch lumber or of hardwood plywood. The back panel is 1/2-inch hardwood plywood. Shelves and dividers are of 3/4-inch lumber. Rabbet the back edges of the top and end panels 1/4 by 1/4 inch. Fasten the bottom to the ends, using glue and No. 4 flat-head screws, 1 1/2 inches long. Then make the shelf assembly, using glue under pressure. At-

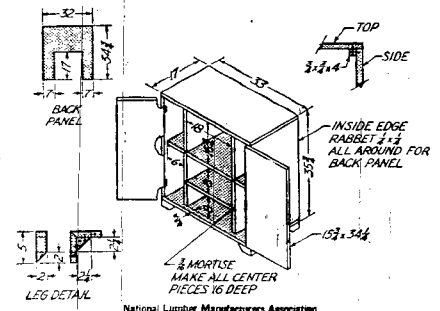

Mr. and Mrs. Clarence Luhr and family were Mother's Day dinner guests in the Oscar Bjorklund home. Eighteen boys were Thursday evening supper guests in the F. W. Salmon home honoring Jimmy's birthday. Arlene Duensing, Beatrice, was a week-end guest in the Charles Peters home.

**Luther Anns Honor Mothers Here Sunday**  
Salem Luther Anns met Sunday afternoon in the Ron Harding home. Mrs. Harding and Marjorie and Mary Beth Longe were hostesses. Mothers of the members were guests and each daughter pinned a carnation on her mother. Etta Jean Park conducted devotions. Sharon Swanson conducted the business session. Mary Beth Longe gave a tribute to mothers. Elaine Nelson sang "Mother."

The missionary lesson was on Dr. Mary Moses, medical missionary to India. Twenty-four members and guests were present. Mr. and Mrs. Ted Jones spent Sunday in the home of Mr. and Mrs. Lester Samuelson, Hartington. Mr. and Mrs. Lawrence Graffis and Marvel Childers were Mother's Day guests of Mrs. Edna Childers, Belden. Mr. and Mrs. William Huselman spent Sunday in Omaha with Mr. and Mrs. Willis Horn. More WAKEFIELD—page 3

## Churches

**Allen Methodist Church** (K. O. Zavadil, pastor) Sunday, May 15: Chimes, 9:30 a. m.; church school, 10; morning worship, 11; baccalaureate service, 8 p. m. Monday, May 16: Quarterly conference, Rev. J. Laverne Jay, O'Neill, 7:30 p. m. Tuesday, May 17: Senior aid; vacation Bible school planning, 8 p. m. Thursday, May 19: WSCS, 2 p. m. Salem Lutheran Church (C. Willard Carlson, pastor) Thursday, May 12: Senior choir practice, 8 p. m.; adult instruction group, 8. Friday, May 13: Junior choir practice, 4:30 p. m. Saturday, May 14: Senior confirmation class, 9 a. m. Sunday, May 15: Sunday school and Bible classes, 9:45 a. m.; worship service, 11. Monday, May 16: Confirmation class dinner, parsonage, 6 p. m.; deacons meeting, 8. Tuesday, May 17: Missionary society, 2 p. m. Wednesday, May 18: Confirmation class trip, 8 a. m. Vacation Bible school, May 23-27.

By insuring careful drivers only, substantial savings are passed on to the policyholder. Can you qualify? Come in today and get the money-saving story.

## Wes Pflueger Agency

Roberts Locker Bldg. Phone 587-W YOU CAN PAY MORE BUT YOU CAN'T BUY BETTER THAN SAFECO

## WAKEFIELD NEWS

By Mrs. George Grimm

**Pleasant Dell Club Has Annual Guest Day**  
Pleasant Dell Club held its annual guest day in the Clarence Boeckenhauer home Thursday afternoon. Mrs. Vern Carlson conducted a business session. A food sale will be held in Concord in June. June picnic will be held in the Wakefield park. Corsages were given to each lady present and May baskets of candy to each child. Readings were given by Minnie Carlson, Mrs. Lloyd Roeber and Mrs. Virgil Green. Serving committee was Mrs. Boeckenhauer and Mrs. Martin Hanson.

**Farewell Open House Planned for Buskirks**  
Presbyterian Westminster federation is planning a farewell open house for Rev. and Mrs. Ronald Buskirk May 21 at the church. Plans were made at a federation meeting Thursday afternoon at the church. Mrs. Walter Moller had the program, "We Are All in This Together." Mrs. Thomas Busby conducted devotions. Serving committee was Mrs. M. J. Busby, Mrs. E. Paul and Mrs. D. P. Quimby. Mr. and Mrs. Lenus Ring were Sunday dinner guests in the Austin Ring home. In the afternoon both families visited Victor Holmberg at Waterbury. Mr. and Mrs. Jerome Pearson and John were Sunday dinner guests in the Waipen Erlanson home. Capt. Eleanor Mathewson, Ft. Riley, Kan., spent the weekend with her mother, Mrs. R. H. Mathewson. Mr. and Mrs. Paul Blomster visited relatives in Bancroft Sunday.

**Amos Boeckenhauer and daughter, Alice, Wayne, and Mrs. Clarence Boeckenhauer, Roger, and Keith, were Sunday afternoon callers in the Elmer Boeckenhauer home.**

**The following were Mother's Day dinner and lunch guests in the Virgil Green home: Mr. and Mrs. George Grimm and Audrey, Mr. and Mrs. Elton Grimm and sons, Sioux Falls, S. D., Mr. and Mrs. Charles Mallum and family and Mr. and Mrs. Wes Anderson and family.**

**Mrs. Gordon Bressler, Kathy and Mark spent the weekend in the home of Mrs. Bressler's sister, Mrs. Don Bahde and children, Kearney.**

**Mr. and Mrs. Walter Woolsoh, North Platte, came Saturday to spend Mother's Day with her parents, Mr. and Mrs. William Victor. Mr. and Mrs. Arnold Victor and Dennis and Mr. and Mrs. Alvin Rast-de were Saturday evening guests in the Victor home.**

**Mr. and Mrs. Charles Peters spent Sunday evening in the Ray Reeg home, Wayne.**

**Mr. and Mrs. Glen Lundahl were Sunday dinner guests in the E. W. Lundahl home.**

**Mr. and Mrs. Albert Sundell and Mrs. Harry Anderson, Denver, were Wednesday evening dinner guests in the Alvin Sundell home.**

## "SHOTGUN" CULTIVATION Saves Time and Money!

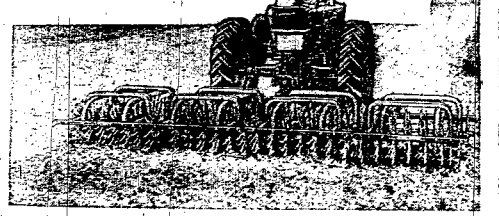

## When Your Hay is Right, Be Ready to Bale

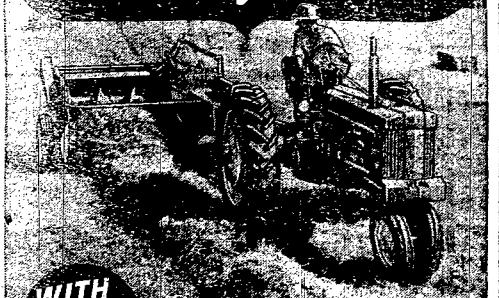

WITH YOUR OWN JOHN DEERE No. 14-T TWINE-TIE BALER

Brandstetter Impl. Co. WAYNE — WINSIDE

See Us For JOHN DEERE QUALITY FARM EQUIPMENT

# NOTICE

## THE WAYNE COUNTY EQUALIZATION BOARD

Will Meet At The Courthouse

### MON., TUES., WED. MAY 16-17-18

Every one likes piping hot "Seaburgers"

### SEABURGERS

- 1 can (7-oz.) of lobster, crabmeat, salmon, or tuna
- 1/2 lb. process sharp cheddar
- 1/4 cup minced onion
- 1/4 cup chopped sweet pickles
- 1/2 cup catsup
- 1/4 cup mayonnaise
- 1 cup minced celery
- 2 teaspoon salt
- 1/2 teaspoon pepper
- 2 tablespoons minced pimiento
- 12 Peter Pan Sliced Buns

Drain seafood and flake with a fork, removing bones. Cut into small chunks. Combine remaining ingredients and mix lightly with seafood and cheese. Spoon mixture onto lower halves of buns, replace top, wrap each bun in foil, and bake for 20 minutes at 350° F. Serve immediately in foil. Makes 12 servings.

And be sure to make them with **Peter Pan SLICED BUNS** for the tastiest sandwich you've ever eaten!

## Who else wants fresher bread?

### We all want fresher bread

Pick Peter Pan in the Polka Dot Wrap—

### and we'll all have fresher bread!



### Wakefield

Mrs. George Grimm  
(Continued from page 2)

### Eighth Graders Are Graduated Here Wednesday

Eighth grade promotion exercises were held in the school auditorium last night with Rev. Samuel Meske giving the main address. Graduates were: Marva Lee Anderson, Wayne Anderson, Patrick Bahde, Roland Barto, Shirleen Bergerson, Robert Harding, Dale Helgren, Sharon Kohnold, Gary Lueders, Lavera Lundahl, Gary Salmon, Robert Schroeder, Lynette Stutz and Patricia Voss.

Diplomas were presented by Harry Larson, school board president. Supt. Raymond Richards presented the class. Rev. Merlin Wright gave the invocation and benediction. Marcia Coe played processionals. A corner trio composed of Dale Helgren, Gary Lueders and Robert Harding played. Shirleen Bergerson and Marvin Anderson played a duet. Miss Bergerson also played a piano solo. Robert Schroeder and Wayne Anderson played a bass duet.

Mr. and Mrs. William Noonan went to Millard Wednesday to attend an open house at the trade school. Billy is attending. Mr. and Mrs. Clayton Anderson and daughters, Norfolk, Mr. and Mrs. Al Pittz and Paul and Mrs. Robert Felt and Jan, North Platte, were Sunday afternoon lunch guests in the Elmer Felt home.

Mr. and Mrs. Clarence Schlines and family, Mr. and Mrs. Albert Schlines and family, Allen, Mr. and Mrs. Lawrence Utecht and Janis, Wayne, Mr. and Mrs. Ronald Ellis and family, Mr. and Mrs. Hans Stark and Joann and Mr. and Mrs. James Hallstrom were Mother's Day guests in the Fred Schlines home. Mr. and Mrs. Karel Walek, Charles and James, Lincoln, Mr. and Mrs. Gale Gay, Lyons, Mr. and Mrs. Eldon Bavelman and family and Mrs. Martha Frevert, Wayne, were Mother's Day cooperative dinner guests in the Henry Bavelman home. In the afternoon Mr. and Mrs. Walek visited Jerry Bavelman who underwent an appendectomy in the Wakefield hospital Saturday. Thursday evening dinner guests in the Emil Ekberg home were Mr. and Mrs. Albert Lundahl and Mr. and Mrs. Lewis Bales. Mr. and Mrs. Fred Mullen called Sunday evening in the Emil Ekberg home. Mrs. Sophia Walters and Mrs. Naomi Echtenkamp were Mother's Day guests in the Harry Bartels home. Mr. and Mrs. Enoch Moore, Emerson, and Wilma Moore, Norfolk, were supper guests Friday in the William Stoner home.

### Minnesota Students Give Sunday Church Program

Four girls from Minnesota Bible college presented a program at the Christian church last Sunday evening. The group is touring Indiana, Wisconsin, Ohio and Canada. Beth Carlson, daughter of Mr. and Mrs. Ivar Carlson, is accompanied for the girls. They were overnight guests in the Carlson home Sunday.

Mr. and Mrs. George Grimm were Friday guests of Mrs. Hazel Taylor, Osmond, and Mr. and Mrs. Truman Mauck, Plainview. Rev. Melvin Pederson will be in Benson Thursday through Sunday conducting special services in the Bensonvale Covenant church.

The following were cooperative supper guests Sunday in the Weldon Morsenson home: Mr. and Mrs. Elmer Bockenhauer, Mr. and Mrs. Lawrence Hanson, Gene and Paul, Mr. and Mrs. LeRoy Griesch and family, Mr. and Mrs. John Bockenhauer and sons and Mr. and Mrs. Clarence Bockenhauer and sons. Mr. and Mrs. Willard Johnson spent the weekend with Mrs. Johnson's parents, Mr. and Mrs. Axel Hageberg, Wausau.

Friday visitors in the E. M. Ekroth home were Mrs. Harry Anderson, Denver, and Mrs. Dale Anderson and daughter. Dr. and Mrs. M. C. Coe, Mary Jane and Marcia spent Mother's Day with Mrs. Coe's mother, Mrs. Earl Hobson, Carson, Ia.

Mrs. C. K. Fischer was a Mother's Day guest in the home of her son, Francis Fischer and family. Mr. and Mrs. Paul Fischer were Sunday evening callers in the Mrs. C. K. Fischer home. The Melvin, Clair and Harold Anderson families were Sunday afternoon and supper guests in the Mrs. Hilma Anderberg home. Mr. and Mrs. Hilding Anderberg were evening callers.

Mr. and Mrs. Axel Smith and Martha, Norfolk, were Wednesday overnight guests in the Oscar Bjorklund home. Mr. and Mrs. Bjorklund and their guests spent Wednesday evening in the Clarence Lahr home.

Mr. and Mrs. Al Borg visited Mr. and Mrs. Dan O'Connell, Mrs. Nellie Wilhelm and Mr. and Mrs. Paul Stromberg, Omaha, Sunday. Mr. and Mrs. Al Borg will go to Alliance Saturday to attend the baptismal services Sunday of their grandson, Timothy Dale. They will return the first of the week.

Mother's Day guests in the George Hubbs home were Mr. and Mrs. Math Hubs and family, Peter, and Mr. and Mrs. Wilbur Hubbs and family, Wayne. Mr. and Mrs. L. R. McCoy were Saturday evening callers in the George Hubbs home.

Mr. and Mrs. Roy Holm returned Saturday following a two-week visit with their daughter, Mrs. A. D. Brown, Birmingham, Ala. They stopped in Kansas City to visit Mr. and Mrs. Richard Means.

Mr. and Mrs. Roy Holm were Sunday dinner guests in the Harry Bartels home and called in the Clarence Holm home that evening. Mr. and Mrs. Lee Stauffer visited Sunday afternoon with Mrs. Stauffer's mother, Mrs. Lena Schultz, Wisner.

Mr. and Mrs. Wilbur Peterson and family spent the weekend in Lincoln. Mr. and Mrs. William Hugelman and his sister, Mrs. Caroline Ackerman, Klamath Falls, Ore., visited Louis Hugelman in Lincoln Friday.

### LOOK WHO'S DRIVING

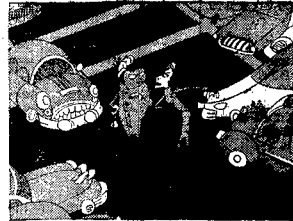

Motorists who hold up traffic while arguing over the right of way...

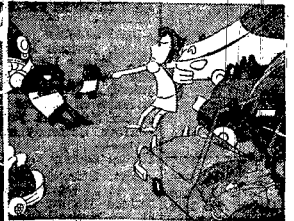

Appeared to Charlie like children fighting over possession of a doll.

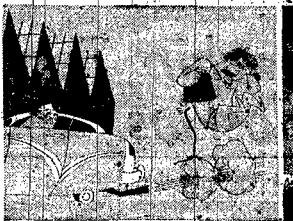

Then there were those who handled a car like a kid would play with a toy.



One night, an impatient driver eager to get home got right behind Charlie.

### STARRING CHARLIE YOUNGHEAD

### Why Save Garbage?



**Disposall**  
Ends unsanitary storage of garbage. Washes food wastes away quickly, effortlessly! Easy to install. Ideal for septic tanks, too!

WAS \$119.95  
**\$69.95**  
Completely Installed

Authorized Dealer  
**GENERAL ELECTRIC DISHWASHERS**

USE DISPOSALL IN ANY SINK

### TIEDTKE Plumbing, Heating & Appliance

108 Main Phone 268

### At VAN'S Friday-Saturday MAY 13-14

Ladies Spring Hats \$1  
Values from 3.95 to 8.95

5T Gauge — 15 Denier  
Mojud Nylons pr. \$1

Betty Rose  
Summer Suits \$11.99  
Unlined Washable Linen

ONE GROUP  
Summer Dresses  
COTTONS 5.77  
AND NYLONS

Boys  
Cotton Anklets 5 pr. \$1  
Girls Knit Polo Shirts \$1  
Colorful Prints — Nylon Reinforced Neck

### VAN'S

210 Main Wayne, Nebr.

# IGA DOLLAR JUBILEE

## Tenderized SMOKED HAM

Butt Ends lb. 45c  
Shank Ends lb. 39c

CENTER SLICES, lb. 69c

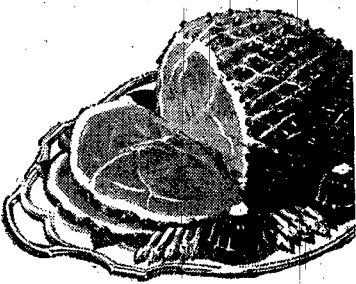

Lake View  
SLICED BACON 3 lbs. \$1.00  
SKINLESS WIENERS 3 lbs. \$1.00  
MINCED HAM 3 lbs. \$1.00  
HAM SALAD OR POTATO SALAD FOR YOUR PICNIC

IGA Cream Style or Whole Kernel Golden  
CORN 8 - 303 cans \$1

IGA Rich Tasty  
TOMATOES 7 - 303 cans \$1

Northern—300's  
FACIAL TISSUE 5 pkgs. \$1

Franco-American  
SPAGHETTI 7 Reg. cans \$1

Campbell's  
TOMATO SOUP 10 Reg. cans \$1

Dog House  
DOG FOOD 12 1-lb. cans \$1

Gerber Chopped or Strained  
BABY FOOD 12 Reg. cans \$1

Fruits and Vegetables  
Extra Fancy Washington Winesap Large Size  
APPLES 2 lbs. 33c

Firm Red Ripe  
Tomatoes cello tube 19c

Tender Crisp California Pascal Cello Package  
Celery Hearts 23c

Fresh Pineapple — Persian Limes — Cucumbers  
Leaf Lettuce

Free Delivery on Orders \$5.00 or More

Opposite Wayne City Auditorium

WE GIVE GOLD ARROW STAMPS WE REDEEM

## Rinehart's Foodliner — Wayne's Food Center

### 3 for \$1

7-oz. Cans  
Star Kist, Light Meat Chunk  
**TUNA FISH**

Del Monte Sliced or Halves  
No. 2 1/2 Cans  
**PEACHES**

Duncan Hines  
**CAKE MIXES**

IGA Dawn  
4-Roll Pkgs.  
**TISSUE**

### 5 for \$1

IGA Ripe 'n Ragged  
No. 211 Cans  
**P'APPLE CHUNKS**

IGA Cut Green  
No. 1 Cans  
**ASPARAGUS**

Karo Blue Label  
1 1/2-lb. Jar  
**SYRUP**

Waxtex  
Regular Rolls  
**WAX PAPER**

### 8 for \$1

IGA Canned  
Tall Cans  
**EVAP. MILK**

Van Camp  
1-lb. Cans  
**PORK & BEANS**

IGA Tasty  
No. 303 Cans  
**SPINACH**

IGA Dark Red  
No. 303 Cans  
**KIDNEY BEANS**

### POST CEREAL VALUES

ENTER THE WIN YOUR OWN PONY CONTEST

5625 PRIZES  
WIN PONIES • SWIM POOLS • TENTS • SKATES!  
IT'S EASY - GET ENTRY BLANKS HERE!

Kraft Assorted  
LINK CHEESE, 6-oz. roll..... 27c

Kraft Natural  
SWISS CHEESE, 8-oz. pkg..... 41c

Marlene — Golden Quarters  
MARGARINE, 1-lb. pkg. .... 22c

Pillsbury or Ballard  
BISCUITS, 2 8-oz. pkgs. .... 29c

A LITTLE CREAM MAKES A BIG DIFFERENCE IN COFFEE

CREAM MAKES A BIG DIFFERENCE IN MARGARINE, TOO! JUST TASTE THE DIFFERENCE

CREAM MAKES IN CREAMO—THE ONLY MARGARINE MADE WITH CREAM

Made from choice vegetable oils blended with fat-free milk, cream, and enriched with 15,000 units of Vitamin A. Distributed by: NASH - FINCH CO.

# Annual Fellowship Tea Held Friday by Hoskins Society

Hoskins EUB church was host to the annual May fellowship tea Friday afternoon in the Brotherhood building. More than 100 persons attended.  
 Mrs. Paul Scheurich gave the welcome. Devotions were led by Mrs. Arnold Wittler, Dorcas president at Peace Reformed church. Others participating in the program were Mrs. Norris

Langenberg, Rev. George Heusinger, Mrs. Harry Suehl, Mrs. Clifford Lindsay, Mrs. Cornelia Leonard, Mrs. William Fenske, Mrs. John Rees, Mrs. M. W. Peterson, Mrs. Harold Neely and Mrs. Harold Ulrich.  
 Spring flowers in WSWS colors of purple and gold decorated the building. Mrs. Myron Walker and Mrs. Robert Holbrook were receptionists. Mrs. George Wittler handled registration. Mrs. Fred Joehens was program chairman.

**11 DOLLAR DAYS**  
**SPECIALS AT GRIESS REXALL**



**LARGE JUMBO BOX WRITING PAPER**  
 120 large flat sheets and 60 envelopes—A 2.50 value for

**\$1.00**

Medford  
**FACIAL TISSUES**  
 300's  
**5 Boxes \$1.00**

Regular 3.00  
**LORIE**  
**FLORAL BOUQUET**  
 Bubble Bath Ass't (3 BOXES)  
**98c**

Griess  
**Rexall Store**  
 WAYNE, NEBRASKA

# "Pitcher of health"



You and your family will feel better and live better with Quality Chekd Homogenized Milk. When you drink Quality Chekd Milk you reduce calcium deficiencies... ease nervous tension... sleep better... feel healthier.

**Patterson**  
 Quality **✓** Chekd  
**HOMOGENIZED MILK**  
 BUY THE PACKAGE WITH THE BIG RED CHECK  
 BUY IT AT YOUR LOCAL FOOD STORE

port. A plant and bulb exchange was held.  
 Mrs. Carl Hinzman and Mrs. Emil Gutzman are June hostesses.  
**Attend Shower**  
 Mrs. Reuben Buss and Peggy, Mrs. Arthur Behmer and Yvonne and Mrs. Herman Buss were among guests attending a shower in honor of Dolores Loeb, Laurel, in the Mrs. Ann Fuhrman home, Norfolk, Saturday evening.

**Dorcas Society**  
 Mrs. Samuel Ulrich was hostess to 28 members of Peace Reformed Dorcas society Thursday at the church. Guests were Mrs. Otto Ulrich, Mrs. David Leuker, Mrs. Erwin Ulrich, Mrs. Emil Pulf, Mrs. C. G. Fuhrman, Mrs. Eliza Franz, Mrs. Robert Wesely, Mrs. Edward Briggs, Amelia Schroeder and LaDonna Ulrich.  
 A group of ladies sang and Rev. George Heusinger sang a solo. Mrs. Arnold Wittler, Mrs. Norris Langenberg and Mrs. Alton Fuhrman made readings. Mrs. Henry Asmus read a poem. Scripture was read by Mrs. Walter Fenske. A Bible quiz was held.  
 Secret sisters were revealed and new names drawn.  
 Gladys and Willis Reichert were Wednesday evening visitors in the Hans Asmus home.  
 Mr. and Mrs. J. E. Pingel were Monday evening visitors in the Louis Bendin home.

## Society ...

**Trinity Ladies Aid**  
 Mrs. Theodore Heberer and Mrs. Lawrence Heberer were hostesses for Trinity Ladies aid Thursday afternoon at the school basement. Four guests and 37 members were present. Guests were Mrs. Martha Rohrke, Mrs. Ernest Fenske, Mr. Dwight Bruggeman and Marjorie Krause.  
 Mrs. Willard Maas conducted the business meeting. Nutshell friends were revealed and new names drawn for the coming year. Rev. G. B. Frank gave a book re-

Erwin Ulrich and Gene, Mrs. Peter Ulrich, Mr. and Mrs. Reuben Pulf, Darwin and Dallas and Mrs. Minnie Brueckner. Afternoon and luncheon guests were Mr. and Mrs. Sam Ulrich and Kenneth Ulrich.

# HOSKINS NEWS

Mrs. J. E. Pingel, Phone 73  
 Mr. and Mrs. Claus Rathman and Russell were visitors in the Henry Liemann home, Norfolk, Tuesday evening.  
 Mr. and Mrs. Albert Behmer, Norfolk, Mr. and Mrs. Lloyd Behmer, Mrs. Henry Asmus and Bonnie and Mrs. Robert Liemann and Cynthia were Sunday afternoon visitors in the E. O. Behmer home.  
 Carol Dorsey and Jack Pingel were Saturday evening visitors in the A. Bruggeman home to visit Merlyn Bruggeman, Ft. Meade, Md., and Dwight Bruggemans.  
 Mr. and Mrs. Dwight Ulrich, Brian Becky and Vickie were Sunday evening visitors in the Erwin Ulrich home.  
 A number of women of Newcomers, A-Teen, Highlands and North Valley Extension clubs attended the spring tea at Wayne last Tuesday.  
 Mr. and Mrs. Ed Winter and Mr. and Mrs. Virgil Buss and family, Belden, were Sunday evening visitors in the Reuben Buss home.  
 Mr. and Mrs. Ernest Lehrer, Mr. and Mrs. Richard Lehrer, Mr. and Mrs. Otto Ulrich and Mrs. Robert Wesely, David, Loretta and Danny were Wednesday visitors in the Erwin Ulrich home.  
 Mr. and Mrs. Clarence Schroeder and Mr. and Mrs. Hans Asmus, Arlene and Gary were Mother's Day supper guests in the Ed Maas home.  
 Mr. and Mrs. Marlen Sprengeler accompanied Duane Riggert, Cheyenne, Wyo., to Norfolk Friday evening where Sprengelers spent

**Mothers Feted By Grade Pupils**  
 Hoskins lower elementary pupils, taught by Mrs. R. A. Duffy, entertained their mothers at a tea Thursday afternoon.  
 Gary Friend led the flag salute. Daryl Mahan played a piano solo. First graders and kindergartners played a singing game. Jeanne Ann Larson played a piano solo. First, second and third graders sang a number. Jerry Holbrook played a piano solo.  
 Third graders presenting a skit were Sandra Kay Olmstead, Mary and Leslie Nielsen, Miss Larson, Sandra Woodman, Daryl Mahan and Nancy Opitz.  
 Refreshments were served by the pupils. Each mother received a potted plant.  
 Mr. and Mrs. Henry Kleensang were Wednesday evening visitors in the William Riggert home.  
 Mr. and Mrs. Marlen Sprengeler, Cheyenne, Wyo., visited Saturday afternoon in the home of her brother-in-law and sister, Mr. and Mrs. Jess Sohl and family.  
 Mr. and Mrs. Truman Clark and family spent the weekend in the home of Mrs. Clark's parents, Bert Lynns, Geneva.  
 Phyllis Maas was a Tuesday overnight guest in the Hans Asmus home.  
 More **HOSKINS**—page 5

## Churches ...

**Hoskins Lutheran Church** (G. B. Frank, pastor)  
 Sunday, May 15: Divine services, holy communion, 10 a. m.; Sunday school, 11; annual school picnic will follow.  
**Evan, United Brethren Church** (Robert Holbrook, pastor)  
 Friday, May 13: Men's chorus. Sunday, May 15: Sunday school, 10 a. m.; morning worship, 11. Thursday, May 19: WSWS.  
**Zion Lutheran Church** (Roy Beckmann, supply pastor)  
 Sunday, May 15: No services or Sunday school. Regular services will be held May 22.

## Don't miss this great SPRING CHICKEN VALUE SHOW

at **SAFeway**

Come pick your favorite chicken—all tender... juicy... and fresh-tasting. Now featured at the Manor House "Spring Chicken Value Show." We're delighted to offer you just that kind of a chicken and chicken parts—quick-frozen Manor House. So delicious it makes any dinner a "Sunday Dinner." And look at these Value Show prices! Try Manor House Chickens today... at **SAFeway**.

<p><b>Fryers</b> Manor House; frozen, cut-up, U. S. Inspected, 1 1/4-lb. average..... Each <b>99c</b></p> <p><b>Drumsticks</b> Manor House; frozen, ready-to-cook, tender morsels for tasty snacks..... 1-lb. Pkg. <b>79c</b></p> <p><b>Breasts</b> Manor House; frozen, ready-to-cook, U. S. Inspected, a real spring value..... 1-lb. Pkg. <b>89c</b></p> <p><b>Thighs</b> Manor House; frozen, U. S. Inspected, ready-to-cook, a delicious lunch box treat..... 1-lb. Pkg. <b>79c</b></p> <p><b>Wings</b> Manor House; frozen, ready-to-cook, U. S. Inspected, enjoy savings with this value..... 1-lb. Pkg. <b>39c</b></p>	<p><b>Sliced Bacon</b> Wilson's Certified; family style pack..... 2-lb. Pkg. <b>98c</b></p> <p><b>Large Bologna</b> Somerset Brand..... 1-lb. <b>39c</b></p> <p><b>Fishsticks</b> Captain's Choice; frozen, golden fried, 10-sticks..... 10-oz. Pkg. <b>39c</b></p> <p><b>Perch Fillets</b> Captain's Choice; frozen, ready to cook..... 1-lb. Pkg. <b>39c</b></p>
--	--

**Make your "Sunday Dinner" complete with these fine foods... at Safeway!**

Corn Country Home; golden, whole kernel, fancy quality.....	12-oz. Cans	<b>29c</b>
Sweet Peas Sugar Belle; blended, fancy quality.....	17-oz. Cans	<b>19c</b>
Potatoes Highway; white, small, whole, new.....	15-oz. Cans	<b>10c</b>
Sweet Pickles Bond's; whole.....	1-pt. Jar	<b>29c</b>
Potatoes Bel-air; frozen, French Fried.....	9-oz. 2 Pkgs.	<b>33c</b>
Potato Chips Diamond brand; fresh.....	9-oz. Bag	<b>39c</b>
Gelatins Jell-well; assorted flavors.....	3 Pkgs.	<b>19c</b>
Strained Honey Empress; pure.....	12-oz. Jar	<b>27c</b>
Fleet Biscuit Mix.....	40-oz. Pkg.	<b>43c</b>

**DID YOU KNOW—**  
 You save more on your total food bill by shopping regularly... at **SAFeway**.

**18 OLDSMOBILES GIVEN AWAY FREE**  
 Enter **Skylark Bread's \$75000 INTER-NATIONAL CONTEST**  
 Get details and entry blanks at **Safeway**  
**Rye Bread** Skylark; sliced, fresh 16-oz. Pkg. **22c**

You Get Quality **TEA GARDEN** Fine Foods

**Extra Special Values on—**  
**TEA GARDEN**  
 Top Quality Sweet Spreads

**Jellies**

Apple Tea Garden; top quality.....	12-oz. Glass	<b>19c</b>
Grape Tea Garden; top quality.....	12-oz. Glass	<b>19c</b>
Plum Tea Garden; top quality.....	12-oz. Glass	<b>19c</b>
Blackberry Tea Garden; top quality.....	12-oz. Glass	<b>27c</b>

**Preserves**

Straawberry Tea Garden; top quality.....	20-oz. Jar	<b>39c</b>
Blackberry Tea Garden; top quality.....	20-oz. Jar	<b>39c</b>
Peach Tea Garden; top quality.....	20-oz. Jar	<b>33c</b>
Apricot Tea Garden; top quality.....	20-oz. Jar	<b>33c</b>
Grape Tea Garden; top quality.....	20-oz. Jar	<b>29c</b>
Plum Tea Garden; top quality.....	20-oz. Jar	<b>29c</b>

**Angel Food Mix** Pillsbury; 13-Egg..... 16-oz. Pkg. **49c**

**Pie Filling** Wilderness; Blueberry, ready to use, (saves you 5¢)..... No. 2 Can **29c**

**Soda Crackers** Busy Baker; 1-lb. fresh..... 2-lb. Box **49c**

**Royal Satin** Pure Vegetable Shortening, all-purpose, for better baking..... 3-lb. Can **79c**

**SWEET CORN** fresh loads daily



**12c lb.**

Tender, golden, "on-the-cob"

Red Tomatoes Firm, fasty, perfect for slicing.....	14-oz. Ctn.	<b>19c</b>
Head Lettuce Fresh, firm, medium size heads.....	1-lb. Lb.	<b>12c</b>
Pascal Celery Crisp, fresh, tender.....	1-lb. Lb.	<b>12c</b>
Grapefruit Florida; medium size, tasty.....	1-lb. Lb.	<b>8c</b>
Apples Newtown Variety; for fresh tasty apple pie.....	2 Lbs.	<b>25c</b>
Avocados Adds zest and flavor to salads.....	Each	<b>15c</b>

**GREEN ONIONS RADISHES CUCUMBERS**

**FLOUR 45c**  
 5-lb. Bag

Special price, over \$100

# Shop SAFeway

Prices effective thru Saturday, May 14, in Wayne

Hoskins

Mrs. J. E. Pingel Phone 73 (Continued from page 4)

Birthday Card Party

Mr. and Mrs. Glen Frink entertained the following guests at their home Friday evening in honor of Mr. Frink's birthday: Mr. and Mrs. Dietz, Bickendahl and family, Mr. and Mrs. Ed Stigstad, Mr. and Mrs. George Platers and family, Mr. and Mrs. Herman Opiet, Bill and Nancy Voss, Mattie Voss and Harry Voss. Prizes were awarded to Mr. and Mrs. Bickendahl and Mr. and Mrs. Bargstad.

Theatre Party

Mr. and Mrs. Ed Kollath entertained the following guests at a theatre party Tuesday evening at Norfolk in honor of Marjorie's sixteenth birthday: Mary Ann Welch, Sandra Asmus, Karen Walker, Dolores Strate, Phyllis Mels, Carolyn and Norma Jean Wittler, Ruth Nurnberg, Delores Galipot, Carol Rathman, Dorothy Friend, Arlene Asmus, Marlene Lorenz, Jacqueline Mittelstaedt and Charlene Kleinbach. Mrs. Henry Asmus and Mrs. J. E. Pingel assisted. Mrs. Kollath with transportation. After the movie Miriam sang a solo, accompanied by her mother, Mrs. Kollath.

Ulrich Reunion Held Here Wednesday Night

Decendants of the late Mr. and Mrs. Peter Ulrich, sr. held a reunion at Immanuel Reformed church Wednesday night in honor of Mr. and Mrs. Erchest Lehrer and Mr. and Mrs. Richard Lehrer, Portland, Ore. Ernest Lehrer formerly lived south of Hoskins. An informal evening was spent and lunch was served.

Carol Dorsey, Sioux City, W.S.C. student, was a supper guest in the E. Pingel home Saturday. Jack Pingel also spent the evening with his parents.

Mrs. Frank Marten and Mrs. Leonard Marten, Patty and Cathy were among guests in the Duane Nathan home last Thursday afternoon.

Mr. and Mrs. Casper Broekemeier, Pierce, were Monday dinner and luncheon guests in the E. Pingel home.

Mrs. Martha Rohrke spent Wednesday in the Frank Miller home, Norfolk. Mr. and Mrs. Frank Miller were Thursday evening visitors in the J. E. Pingel home.

Mr. and Mrs. Lloyd Wilson were visitors in the Max Krueger home Tuesday evening. Mr. and Mrs. Frank Miller were among guests at the William Woockman home Monday evening, honoring Mr. Woockman's birthday.

Mrs. Victor Clocker and Arjean Wilson spent Monday afternoon in the Max Krueger home. Mr. and Mrs. Max Krueger and family were visitors in the Arthur Krueger home, Pierce, Wednesday evening.

Mr. and Mrs. Clarence Woockman and family were last Sunday dinner guests in the William Woockman home, Pierce, in honor of Mr. Woockman's birthday.

Housewarming Honors Duane Nathan Family

Mr. and Mrs. Duane Nathan and family were honored at a housewarming at their home last Sunday evening.

Pitch prizes went to Mrs. Leroy Klug, Mrs. Woockman, Mrs. Jochens, Mr. Wilson, Mr. Buss and A. Nathan. Guests were Mr. and Mrs. Harry Hansen and Md. and Mrs. A. Nathan and family, Norfolk. Mr. and Mrs. Robert Hansen and family, Mr. and Mrs. William DeWolf, Mr. and Mrs. Reuben Ezra Jochens and family, Mr. and Mrs. Elmer Chapman and family, Mr. and Mrs. Iryl Swenson and family, Mr. and Mrs. Lloyd Wilson, Mr. and Mrs. Al Wurdinger, Mr. and Mrs. Harry Weiher, Mr. and Mrs. Leroy Klug and family, Mr. and Mrs. Lloyd Klug and family, Mr. and Mrs. Max Krueger and family and Mr. and Mrs. Jerome Woockman.

Mr. and Mrs. Walter Bethwisch and Connie were last Sunday visitors in the Henry Voss home.

Mr. and Mrs. Herbert Pfeil were Saturday evening visitors in the Gerhard Weber home, Plainville.

Douina Rae Frink, Omaha, spent the weekend in the home of her parents, Mr. and Mrs. Glen Frink. Herbert Krause was a Saturday morning visitor in the Mrs. Minnie Krause home.

Mr. and Mrs. Edwin Moean and family, Madison, were Sunday afternoon visitors in the Willard Maas home.

Mr. and Mrs. Herbert Schwindt and Dorothy Stanton, were Tuesday evening visitors in the Mrs. Minnie Krause home. Mr. and Mrs. J. E. Pingel were Monday evening visitors in the Louis Bendin home.

Myron and Lester Deck, Stanley Schellpepper, Weldon Marotz and Ronnie Schellpepper left Thursday morning to spend several days fishing in South Dakota. Mr. and Mrs. Everett Newman and family, Mr. and Mrs. Elmer Mads and Mr. and Mrs. Harlan Herbolshier, Jeanette and Dy Ann, Pierce, were visitors in the Ed Shellenberg home Thursday evening.

Mrs. Harry Fry, Lincoln, spent Friday and Saturday in the home of her daughter, Willard Maas and family.

Mr. and Mrs. A. J. Jones and family, Shoels, visited Sunday in the Henry Voss home. Mr. and Mrs. Willard Maas and family were last Sunday afternoon

visitors in the Otto Kurgswelt home, Leigh. Mr. and Mrs. J. E. Pingel visited Monday evening in the Raymond Lippert home.

Mrs. Martha Rohrke and Mrs. Emelia Schmidt were Sunday supper guests in the J. E. Pingel home. Walt Broekemeier, Lincoln, spent the weekend in the home of his sister, Mrs. J. E. Pingel and family.

Mr. and Mrs. Arthur Uecker were visitors in the Frank Miller home Wednesday evening. Mrs. Martha Rohrke and Mrs. Frank Miller were among guests Wednesday afternoon of Mrs. Paul Wetzel, Norfolk, for her birthday.

Mr. and Mrs. Hans P. Hanson and Mr. and Mrs. Herman Rohrk, Wayne, were Thursday dinner guests in the home of Mrs. Hansen's and Mrs. Reubig's uncle, Charley Anderson, South Sioux City. They were afternoon visitors in the Carl Austin home, Sioux City.

Mr. and Mrs. Lloyd Bemer and family visited in the E. O. Behmer home Saturday evening.

Koepkes Wed Forty Years; Feted Sunday

Mr. and Mrs. Otto Koepke celebrated their fortieth wedding anniversary Sunday evening at their home with approximately 60 guests present.

Progressive pitch furnished entertainment with prizes going to Mrs. Harlan Grimm, Mrs. Edwin Strate, Mrs. Helmer Pofahl, Gilbert Grimm, Edward Bernhard and Herman Koepke.

Mrs. Herman Marks, Tilden, an attendant at the wedding, was among the guests. A three-tier cake baked and decorated by Mrs. Lester Koepke and Mrs. Elmer Koepke centered the refreshment table.

Guests were from Utica, Fremont, Stanton, Norfolk, Pierce, Tilden, Carroll and Wayne.

Mr. and Mrs. J. E. Pingel and Walk Broekemeier, Lincoln, were Saturday visitors in the Casper Broekemeier home, Pierce.

Mr. and Mrs. E. O. Behmer, Mr. and Mrs. Fred Puls, Mrs. Emma Bauermiester and Mrs. Emelie Fuhrman were last Sunday dinner guests in the Alton Fuhrman home.

Mrs. Harry Strate and Mrs. Louis Bendin were Friday afternoon callers in the J. E. Pingel home.

Mr. and Mrs. Don Perrin and Linda and Mrs. Susie Perrin, Norfolk, were Thursday evening visitors in the Rasmus Nielsen home.

Rev. and Mrs. G. B. Frank and family were supper guests in the Fred Marquardt home Friday evening.

Winifred Miller and granddaughter, Debbie Williams, spent Saturday afternoon and evening in the William Riggert home.

Delores Grimm, Norfolk, and Lloyd Mittelstaedt, Hadar, were Sunday afternoon and supper guests in the Victor Klug home.

Mr. and Mrs. Lester Koepke and family were visitors Thursday evening in the William Riggert home to see Mrs. Duane Riggert and children.

Mr. and Mrs. Herman Meyer and Chris Lorenz, Osmond, were Sunday dinner guests in the Harry Weiher home.

Mr. and Mrs. J. E. Pingel were among guests attending a family dinner in the W. F. Broekemeier home, Osmond, Sunday. They were evening visitors in the Mrs. Pauline Wubbenhorst home.

Mr. and Mrs. Robert Boyd, Norfolk, and Mr. and Mrs. E. O. Behmer were Sunday evening visitors in the Mrs. Emelie Schmidt home.

Mrs. Bert Lynn, Geneva, spent several days last week in the home of her daughter, Mrs. Truman Clark and family.

Mr. and Mrs. Clarence Schroeder and Mr. and Mrs. Hans Asmus, Arlene and Gary were supper guests in the Ed Maas home Sunday.

Mr. and Mrs. Fred Frevert, Wayne, were visitors in the E. O. Behmer home Friday afternoon.

Mr. and Mrs. Reuben Buss and Peggy, Lt. Robert Buss, Selfridge, Mich., and Delores Loeb, Laurel, were Mothers' Day dinner guests in the Virgil Buss home, Belgden.

Mrs. Theodore Heberer, Mrs. Mattie Voss and Mrs. Ernest Puls were Thursday evening visitors in the Mrs. Minnie Krause home.

The Wayne (Nebr.) Herald, Thursday, May 12, 1955

Dollar Days May 13-14

YOUR BUDGET WILL LOVE OUR FOOD PRICES

BUY YOUR GILLETTE PRODUCTS HERE

All Popular Brands COFFEE lb. 79c With \$3 Order

Sunshine KRISPY CRACKERS, 2 lbs. 53c Supreme Bakers

Coconut Choc. DROP COOKIES, lb. 49c

Blue Bunny Ice Cream All Flavors 1/2 gal. 98c Pure Sun 6-oz. cans

Orange Base 2 for 33c Van Camp's No. 2 cans

Pork & Beans 2 for 37c Towne Pride CONCENTRATED

FRUIT DRINK Made of Pure Fruit Juices - No Sugar Required 5 1/2-oz. can makes a full quart 2 cans 31c

Hellman's Real Mayonnaise pt. 38c

Swift Premium Sliced Bacon lb. 53c

All Sweet OLEO 4 lb.s \$1

Fresh Dressed Home Grown FRYING CHICKENS lb. 56c

New Cabbage 2 lbs. 11c

Carrots 2 cello bags 19c

CITY GROCERY We Deliver - 10 a.m. and 4 p.m. Daily 214 Main Phone 355

Wayne SPECIAL SAVINGS COUNCIL STORES BLUE RIBBON OLEO 235c MARSH-MALLOWES 19c TOMATO JUICE 25c SLICED PORK LIVER 59c GROUND BEEF 3 LBS. 89c BANANAS... 2 LBS. 29c RADISHES 2 BUNCHES 9c POTATOES 10 LBS. 49c HEAD LETTUCE 15c WAXTEX 100 FT. ROLL 21c SUM-RAID 25c FLOUR 329c Northern Tissue 100 12 Rolls White or Colored Superb FRUIT COCKTAIL Morning Light RED CHERRIES 4 No. 303 cans Hawaiian Sliced or Crushed Pineapple 100 4 No. 2 cans

**NORTHWEST Wakefield**

By Mrs. Wallace Ring (Wakefield Atlas 7-2872)

Mr. and Mrs. Bob Mahan and Jimmie, Sioux City, spent Friday with Hjalmer Lunds.

For Mother's Day Mr. and Mrs. Lawrence Johnson, Mr. and Mrs. Kenneth Packer and daughters and Mr. and Mrs. Gene Packer and Pamela were afternoon luncheon guests in the John N. Johnson home.

Lt. and Mrs. Richard Pospisil have returned to Laredo, Tex., after a visit with relatives here.

Mr. and Mrs. Thure Johnson visited her mother, Mrs. Axel Fredrickson, in Sioux City Lutheran hospital Sunday afternoon.

Mr. and Mrs. Don Denbeck and baby were Sunday dinner guests in the Emil Roeber home.

Bruce and Byron Roeber spent Tuesday with their grandmother, Mrs. Clarence Utmark.

Mrs. Don Dyer and Leone Anderson were entertained at Sunday supper in the Marvin Stolle home.

Mr. and Mrs. Ben Lund entertained Mr. and Mrs. Verdel Lund and sons at Sunday dinner and supper.

Mr. and Mrs. Purl Fisher, Lincoln, visited her niece, Mrs. Clarence Wolter and family, from Thursday to Saturday.

Clarence Wolters entertained Walt Utechts at a fish supper last Monday.

Ivan Nixon and Kermit Turner were in Omaha Monday marketing cattle.

Mr. and Mrs. Paul Gerdes and Janet Sue, Lexington, came Saturday to spend Mother's Day in the Emil Miller home. They returned home Monday morning.

Mr. and Mrs. A. G. Schager visited Mrs. Axel Fredrickson in a Sioux City hospital Saturday.

Arlene Duensing, Beatrice, spent the weekend in the Charles Peters home and accompanied them to the Oscar Becker, sr. home for a family dinner Sunday.

Mr. and Mrs. Levi Dahlgren drove to Central City Thursday where they met their daughter, Mrs. Robert Turnquist and Marv. Axtell, who will spend the week with home folks. Friday afternoon Mrs. Dahlgren and guests visited Edna Dahlgren.

Sunday afternoon Mrs. Levi Dahlgren, Mrs. Robert Turnquist and Edna Dahlgren attended the organ recital at St. Paul's church in Wayne. Mr. and Mrs. Wallace Ring also attended.

For Mother's Day a group of relatives had dinner and supper in the Mrs. Fred Johnson home. Included were her mother, Mrs. Lena Penke, who was able to leave the hospital for the day. Mr. and Mrs. Elmer Christensen and Mrs. Sophia Christensen, Bennington, Mr. and Mrs. John Dail, Norma Jean and Karen, Concord, Mr. and Mrs. Leo Schulz and children, Mr. and Mrs. Floyd Johnson and three daughters and Mr. and Mrs. Clarence Nelson and two daughters.

Mrs. Oskar Bloomquist visited her sister, Mrs. Paul Dahlgren Friday afternoon.

Mr. and Mrs. A. G. Schager were Sunday afternoon luncheon guests in the Mrs. Elsie Anderson home, Hartington.

Mr. and Mrs. Adolph Berg, Sioux City, were Monday dinner guests in the Mrs. Joel Dahlgren home. Bob Dahlgren is expected home from Mt. Ephraim, N. J., the latter part of the week.

Mrs. Jess Brownell and Mrs. Oscar Johnson spent Thursday afternoon with Mrs. Thure Johnson.

Shirley Lehman and Bill Gugges were Sunday evening guests at Gene Packer's.

Mr. and Mrs. Clarence Walter had as Sunday dinner and supper guests Mrs. Bertha Wolter and Mr. and Mrs. Bill Klein and children, Battle Creek.

Mr. and Mrs. Charles Peters and Kevin spent Sunday evening with Ray Reegs, Wayne.

Mr. and Mrs. Lloyd Roeber and sons spent Wednesday evening with Don Johnsons.

A family dinner was enjoyed in the Harry Bartels home for Mother's Day. Guests were Mrs. Sophia Walters, Mrs. Naoma Echtenkamp and Merin, Mr. and Mrs. Irvin Bartels, Gene and Willard, Mr. and Mrs. Roy Holm, Lois and Helen, Mr. and Mrs. Bob Schenck and Robin and Mr. and Mrs. Lawrence Johnson.

Mr. and Mrs. Irvin Bartels, Verna Mae and Eugene were Sunday supper guests in the Ralph Beardsley home, Sioux City.

Last Sunday dinner and supper guests in the Vernon Schultz home were Mr. and Mrs. Fred Evers, Laurel, Mr. and Mrs. Myron Schultz and children, Wayne, and Mr. and Mrs. Leslie Sherman, Mrs. Opal Schultz and Alfred Bokken, Newcastle.

**'I See by The Herald'**  
Items about Wayne folks you know

Mrs. Noah Bolton and Mrs. Elmer Giambius, Wisner, visited in the T. C. Bathke home Saturday. Mr. and Mrs. Charlie Bolton, Ponca, Mr. and Mrs. Roy Bolton, Norfolk, and Mrs. Herman Sund were Sunday visitors.

Robert Bathke, Papillion, spent the weekend with T. C. Bathkes.

Mr. and Mrs. August Brudigam and Mr. and Mrs. Marvin Brudigam and family were Mother's Day dinner guests at the Howard Wacker home.

Guests at the Carl Doeschler home Sunday were Mr. and Mrs. Ed Doeschler and family, Concord, Mr. and Mrs. Floyd Johnson and family and Mr. and Mrs. Willard Alexander and family, Laurel. Mr. and Mrs. Art Doeschler and family were evening guests.

Orville Exlebentz entertained for dinner Sunday evening: Mr. and Mrs. Emil Carsten, Mr. and Mrs. Warren Carsten and Mrs. Leola Rathke, all of Wisner, and Mr. and Mrs. James Jensen and Lyndon, Wakefield.

A. R. Ellis came home Saturday afternoon to spend 10 days and again return to the veteran's hospital in Omaha.

Mr. and Mrs. Bill Carlson and family visited with Mrs. Walfred Carlson Sunday.

Mr. and Mrs. Stanley Samuelson and family, Lyons, spent Saturday evening with S. E. Samuelsons.

Mrs. Adon Jeffrey's brother, Don Alderman, Long Beach, Calif., came Thursday and stayed until Sunday with her, Mr. and Mrs. John Alderman and family. Bassett, spent the weekend in the Jeffrey home and Sunday O. M. Jeffreys, Plainview, were dinner guests with the others. Don returned with his brother's family to Bassett to visit before leaving for California.

George Peter brought his wife and children from Omaha to Wayne where they will spend a week with her parents, Paul Mines.

Burrett, Claude, and Carl Wrights were dinner guests Sunday in the Tom Blainford home, Newcastle.

Karol Lou Kay, Fremont, spent the weekend with her parents, Harry G. Kays.

Annis J. Hamer spent the week-end with her grandparents, Mr. and Mrs. David Hamer sr.

Mr. and Mrs. Harold Freese and family, Lyons, visited Sunday evening with his parents, Mr. and Mrs. Herman Freese.

Mr. and Mrs. Frank Heine and Mrs. Barbara Lerner, went to Stanton for Sunday dinner in the Jack Anderson home. Mrs. Anderson is a daughter of the Heines.

Sunday dinner guests in the Fred Stone, sr. home, Laurel, were Mr.

and Mrs. Frank Griffin and Mr. and Mrs. Carl Victor, Mr. and Mrs. Robert Stone and family, Norfolk, and Mr. and Mrs. Fred Stone and family, Laurel.

Carl F. Meyers entertained for Sunday dinner Mr. and Mrs. Don Kanzler and Connie, Lincoln, Mr. and Mrs. Bob Meyer and family, and Mr. and Mrs. Don Meyer and family.

Mr. and Mrs. M. I. Swihart, Carroll, came Sunday and were overnight guests in the Evan Hamor home. Mrs. Charles Scriber and children, South Sioux City, came Tuesday to the Hamer home. Mrs. Scriber went on to Fremont to attend an Eastern Star convention until Friday. Her children are remaining with the Hamers.

**Don't Take A Chance!**

USE **HEPTACHLOR**

for the safe control of corn rootworm, wire worms, cut worms. One bushel of corn increase will more than pay the cost of band treatment.

CUSTOM APPLIED OR RENT ONE OF OUR SPRAYERS.

**NORTH EASTERN FERTILIZER CO.**

"Your Fertilizer Headquarters"

111 S. Main Wayne Phone 60

Ivan Nixon were Saturday supper guests at (a) Swagertys.

Friday evening Mr. and Mrs. Carolyn Crook and Joan visited Lloyd Roebers.

Mr. and Mrs. Ernest Packer accompanied Mr. and Mrs. Henry Kreiger, Peher, to St. Croix, Wis., Friday, Saturday they attended the marriage of Dixie Leigh Packer, daughter of Mr. and Mrs. Levinus Packer, to Larry Baird, Picketstown, S. D. The wedding was in Forrest Lake, Minn. The newlyweds will live in Swan Valley, Idaho. Packers and Kreigers are grandparents of Dixie Leigh. They returned Sunday.

Mr. and Mrs. Art Meyer visited in the home of his parents, Mr. and Mrs. William A. Meyer, Wayne, Sunday afternoon, and were supper guests in the Delbert Jensen home to help their grandson, Jerry, celebrate his fourth birthday.

Last Monday evening Mr. and Mrs. Art Meyer were guests of Mr. and Mrs. Fred Schines.

Mr. and Mrs. Theron Culton and daughters were in Sioux City Sunday. They visited his mother, Mrs. Catherine Culton, at St. Joseph's hospital and also Bob Cultons.

Sunday the Ivan Nixon family enjoyed a cooperative dinner in the Glenn Cooper home, Bancroft. About 40 were present.

Mrs. Cal Swagert and Mrs. Kermit Turner spent Monday in Sioux City.

*We Protect*

**YOUR FAMILY'S HEALTH**

**WAYNE COUNTY PRODUCER ...**



GILLETTE DAIRY and its producers cooperate to bring you pure, wholesome milk at its freshest ... and Gillette purchases enough milk in Wayne County to furnish a quart of milk to every person in Wayne daily.

Grade A Milk Homo Milk

**GOOD YEAR**

**REPEAT SALE**



THE NEW, LOW-COST **SUPER-CUSHION** WITH HIGH PRICED FEATURES

**\$15.95** Plus Tax and Recappable Tire Size 6.70 x 15

Regular No Trade-In Price \$18.70

**CORYELL AUTO-OIL COMPANY**

211 Logan Phone 305-W

Sale Prices On Both Blacks and Whitewalls	
TIRE SIZE	SALE PRICE* with Trade-in
6.00 x 16	\$16.75
6.40 x 15	17.85
6.70 x 15	18.70
7.10 x 15	20.70
7.60 x 15	22.65
6.50 x 16	22.25

WHITE SIDEWALL SALE PRICES	
TIRE SIZE	SALE PRICE* with Trade-in
6.00 x 16	\$20.50
6.70 x 15	22.90
7.10 x 15	25.35
7.60 x 15	27.75
6.50 x 16	27.25

\*Regular prices are plus tax. Sale prices are plus tax and recappable tire.

... AND **GILLETTE DAIRY**

*by using this*



**ALMOST HUMAN** Pure-Pak MACHINE



Here's why all Gillette Milk in Pure-Pak Containers is always pure and delicious. Rubber "fingers" feed container blanks in at one end of the machine. Metal fingers form the containers which then go into a sterilizing chamber. Each container is hot-paraffin sterilized inside and out. Immediately, the containers are chilled, accurately filled through the open top and hermetically sealed. It's all done in seconds, in our dairy, without the touch of human hands! When you buy Gillette milk in Pure-Pak, you are the first to break Pure-Pak tamper-proof pouring seal!

**GILLETTE HIGH QUALITY PRODUCTS**

Grade A Milk	Coffee Cream	Half & Half	Lactone	Orange Drink
Homogenized Milk	Whipping Cream	Chocolate Milk	Cottage Cheese	Butter

AVAILABLE AT THESE STORES

COUNCIL OAK STORE "Your Friend at Mealtime"	CITY GROCERY "Quality at the Best Prices"	RINEHART'S IGA Foodliner
SAFEGWAY STORES Inc.	ARNIE'S SUPERETTE Open Evenings and Sunday a.m.	SHARER'S GROCERY "In Business for Your Health"

**DAILY HOUSE DELIVERY-BOB PILE-PHONE 682**



**Leslie**

By Mrs. George Buskirk  
Phone Atlas 7-2523

**Triple Birthday**  
Mr. and Mrs. Darrel Thomsen and family were Sunday dinner guests at Herman Thomsen's. They were afternoon visitors at Denis Sebade, celebrating the birthdays of three cousins, Denise Sebade, Ronnie Sebade and Dennis Thomsen.

**Aid With Moving**  
Mr. and Mrs. August Kai and Judy were Sunday dinner visitors at Clarence Mann's, Wayne. They were assisting Mann in moving into their new home. Mr. and Mrs. Ronnie Mann moved into the house vacated by Mann's.

**Sixty-Fifth Wedding**  
Mr. and Mrs. William Fehrs celebrated their sixty-fifth wedding anniversary in Omaha Wednesday. He is confined to a hospital at present. They are former residents here.

Mr. and Mrs. Gilbert Rauss were Tuesday evening visitors at Ervin Bottgers. Mr. and Mrs. Paul Henschke, were Wednesday evening visitors there.

Mr. and Mrs. Adolph Henschke visited at Carl Freverts Sunday. Mr. and Mrs. Ervin Bottger and Mr. and Mrs. Ben Bottger were Thursday dinner guests at Mrs. Fred Meines, Wakefield.

Mr. and Mrs. Ed Krusemark and family were Sunday dinner guests at William Krusemarks. They were Friday evening visitors at Willis Krusemarks.

Mrs. Henry Hinnerichs, Wayne, was a weekend guest at Elwood Sampsons. Walt Johnsons were

Sunday evening visitors. Ronnie Sampson underwent surgery at Wakefield hospital Thursday. Mr. and Mrs. Emil Kai were Sunday dinner guests of Mr. and Mrs. Dick Kai.

Dick Kai spent Sunday evening at Donald Kai's east of Allen and report a heavy rain shower there. Mrs. Marnie Hansen, Wisner, was a weekend guest of Henry Korths, Tommy Dowty, Omaha, was a Sunday caller.

Last Tuesday Mrs. Henry Korth accompanied Mrs. Lyle Dowty to Norfolk to visit with her brother from Colorado.

Mrs. Henry Bush was a Friday caller at Elwood Sampsons on her way to the Cecil Stallbaum home to assist a few days as the twins were to be brought home from the Sioux City hospital.

Mrs. Dan Dolph attended Plum Creek club at Mrs. Homer Biermann's Wednesday.

**Farmers Union Sees Serviceman's Slides**  
Leslie Farmers Union met Friday evening at A. W. Dolph's. Following the regular meeting Herbert Biermann who spent 17 months in Korea and Japan showed slides taken while on his travels.

Mr. and Mrs. Harry Longe, Omaha. Mr. and Mrs. Glen Longe and Mr. and Mrs. Donnie Longe and family were Sunday dinner guests at the Bill Longe home. Mr. and Mrs. Herman Baker and Mr. and Mrs. Louis Test were evening visitors.

Mr. and Mrs. John Vogt and family. Mrs. Augusta Westerboid. Mr. and Mrs. Marvin Moeller and family. Mr. and Mrs. Harry Myers and Gus Anderson were Sunday dinner guests at the Richard My-

ers home. Luncheon guests were Mr. and Mrs. Marvin Rouse, Blair. Mr. and Mrs. Willard Kiefer and Mrs. Mary Kiefer, Lyons. Thursday supper guests were Mr. and Mrs. Ed Rouser, Omaha, and Mr. and Mrs. Harry Myers, Lyons. Vaughn Korth enjoyed visitors Thursday evening for his birthday.

Mr. and Mrs. Dick Iverson, Sioux City. Mr. and Mrs. Meritt Bressler, Lincoln, were Sunday guests at L. J. Bressler's.

Mr. and Mrs. Darrel Puckett and family and Mr. and Mrs. P. R. Greaser were Sunday dinner guests at the Memo Erl home, Wakefield. Mr. and Mrs. Puckett attended a church meeting in Norfolk in the evening.

Mr. and Mrs. L. J. Bressler were Friday dinner guests of Mrs. Dick Iverson, South Sioux City, where she teaches.

Mr. and Mrs. Billy Hansen and family. Mr. and Mrs. Joe Wilson. Mr. and Mrs. Jack Schroeder and Mr. and Mrs. Robert Hansen and Dale were Sunday dinner guests of Mrs. Mary Hansen. Mr. and Mrs. Henry Tarnow were evening visitors.

Mrs. Mable Clinkenbeard is visiting relatives and friends at Thurston.

Mr. and Mrs. Harry Steinhoff and Noreen, Bancroft, were Sunday visitors at Clark Kai's.

Mr. and Mrs. Marvin Meier were Monday visitors at Art Meyer's and Friday evening were at Max Henschke's. Sunday they were at Wausa and dinner guests at Dale Brockman's.

Mr. and Mrs. George Habrock and family. Mr. and Mrs. Don Dolph. Mr. and Mrs. Lowell Baker and Mr. and Mrs. Forrest Peters and family were dinner guests Sunday at Herman Baker's. Dan Dolphs spent Sunday evening with A. W. Dolphs, Wayne.

Mr. and Mrs. Jack Magire, Omaha, and Mrs. Marie Hansen, Pender were Friday evening vis-

itors at Emil Tarnows. Thursday evening a group of visitors were at Fred Tarnows helping him celebrate his birthday. Mr. and Mrs. Henry Tarnow marketed stock in Sioux City, Thursday. Mr. and Mrs. LeRoy Lundahl and sons were Sunday dinner guests at the Henry Tarnow home.

**SALES BOOKS FOR ALL BUSINESSES**

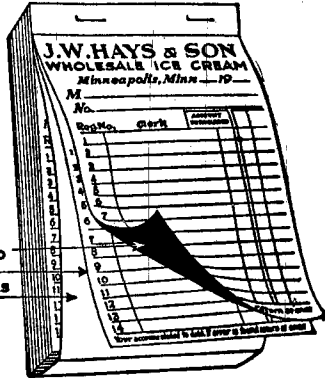

ORIGINAL CARBON COATED DUPLICATE COVER, USED AS STOP CARD

**The Wayne Herald**

Office Supplies Dept.

Telephone 130

**Aluminum Office Chairs**

"A Chair For Every Seated Worker"

**UTILITY**

**COMFORT**

**DURABILITY**

Wherever a worker is seated, the chair becomes an important part of the job. For greatest worker efficiency the chair must provide the worker with a maximum of comfort, proper posture and mobility yet be durable and attractive. When you have a seated worker, look to Cramer chairs, engineered for posture.



No. 922



No. 921

**Increase Efficiency ...**

With your worker seated in an aluminum posture chair, his efficiency is greater, due to greater comfort, proper posture, easy instant control of height, Airflow seats and cushions.



No. 920

**REDUCE FATIGUE ...**

Posture Chairs keep fatigue at a minimum by holding the worker in the proper posture easily and comfortably throughout the working day. Fatigue costs money you can save with aluminum Posture Chairs. No backache or cramped muscles.



No. 903

**ADD BEAUTY ...**

Though these chairs are engineered first for proper posture, they have the true beauty that comes with utility and simplicity of design. Their lightweight aluminum framework, enhanced with modern, durable covers, are a bright spot in any office.



No. 902

**VARIETY OF COLORS AND FABRICS**

Aluminum Posture Chairs are available in a variety of fabrics all in standard colors to match other office equipment. Tough, durable Naugahyde plastic, Grospoint mohair or Claremont fabric. When you buy chairs, look to Cramer, for the best.



No. 901



No. 900

**ON SALE AT ...**

**THE WAYNE HERALD**

**ENROLL NOW**

MAY 16 through 21

For

**Blue Cross - Blue Shield**

HOSPITAL-MEDICAL PROTECTION

Individual (Non-group) Enrollment

**IN WAYNE**

During the Special Community Campaign

**SAVE \$4.00 NOW!**

On Your First Membership Dues

The Usual Enrollment Fees of \$2.00 for Blue Cross and \$2.00 for Blue Shield Will Not Be Charged During This Local Community Campaign



NEBRASKA BLUE CROSS  
Has the Official Approval of the American Hospital Assoc. and the Nebraska Hospital Assoc.

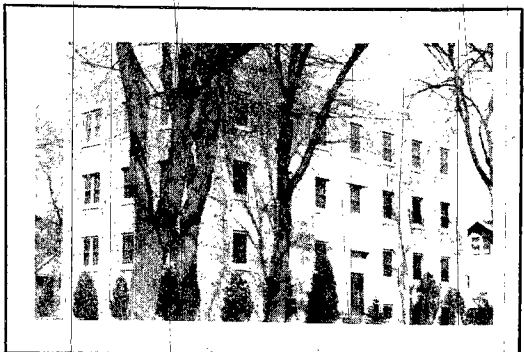

NEBRASKA BLUE SHIELD  
Has the Official Approval of the Nebraska State Medical Association

This Community Campaign is Sponsored by

**HOSPITAL and PHYSICIANS In WAYNE AREA**

Enrollment Representative

**VIRGIL W. LEACH - MORRISON HOTEL**